

CE

SGE

Condensing Gas-Solar
Water Heater

SGE - 40/60



Installation, User and Service
Manual

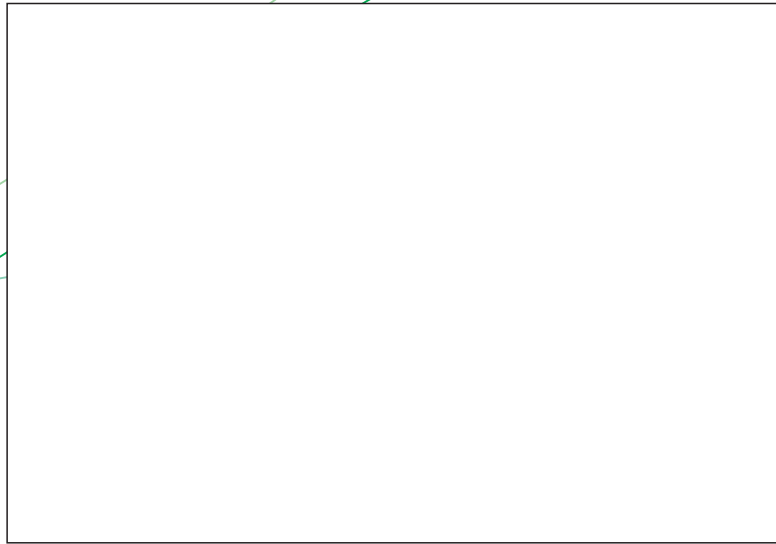

your installer

Errata

The amendments below apply to:

- the preparation of the electrical connection of the solar heating control ([3.12.1 "Preparation"](#));
- finishing maintenance ([15.6 "Finalizing maintenance"](#));
- the electrical diagram of the solar heating control ([17.4 "Electrical diagram solar heating system"](#)).

These instructions supersede the previous instructions of the solar heating control.

3.12.1 Preparation

Remove the cover (snap-on type) from the terminal block of the solar heating control.

This has the following terminals:

Power			n.a.	n.a.	not applicable				Pump (solar)				not applicable			not applicable			
⏏	L	N	-	-	-	-	-	-	⏏	L ₃	N	L ₄	-	-	-	-	-	-	-
1	2	3	4	5	6	7	8	9	10	11	12	13	14	15	16	17	18	19	20

not applicable	Sensor S ₁	not applicable	Sensor S ₁	not applicable	Sensor S ₂	not applicable	Sensor S ₂	not applicable	not applicable	not applicable	not applicable	not applicable	Power 5V	Sensor S ₄	⏏	Flow signal	not applicable	not applicable	BUS-link	BUS-link
J13				J14				J3				J12				J15		J16		
1	2	3	4	1	2	3	4	1	2	3	4	1	2	3	4	1	2	1	2	

15.6 Finalizing maintenance

To finalize the maintenance, carry out the following steps:

1. Fill the water heater ([5 "Filling"](#)).
2. Start the water heater ([9 "Starting the water heater"](#)).
3. Check the CO₂ value ([3.12.3 "CO₂ adjustment"](#)).
4. Check the switching pressure of the pressure switch. ([3.12.4 "Switching pressure measurement"](#))
5. Erase the message SERVICE REQUIRED. The displayed message can be reset in either of two ways.

1. Temporary reset:

To postpone the message, press RESET once. The message will reappear on the display 7 days later.

2. Full reset:

To fully reset the message, press and hold both RESET and ENTER at the same time for 5 sec.

On completion of the full reset of the message, the message below will appear on the display. This message will NOT be shown after a temporary rest of the message.

```

RESET
SERVICE INTERVAL
SUCCEFUL
    
```

**17.3 Electrical diagram
solar heating
system**

Electrical diagram

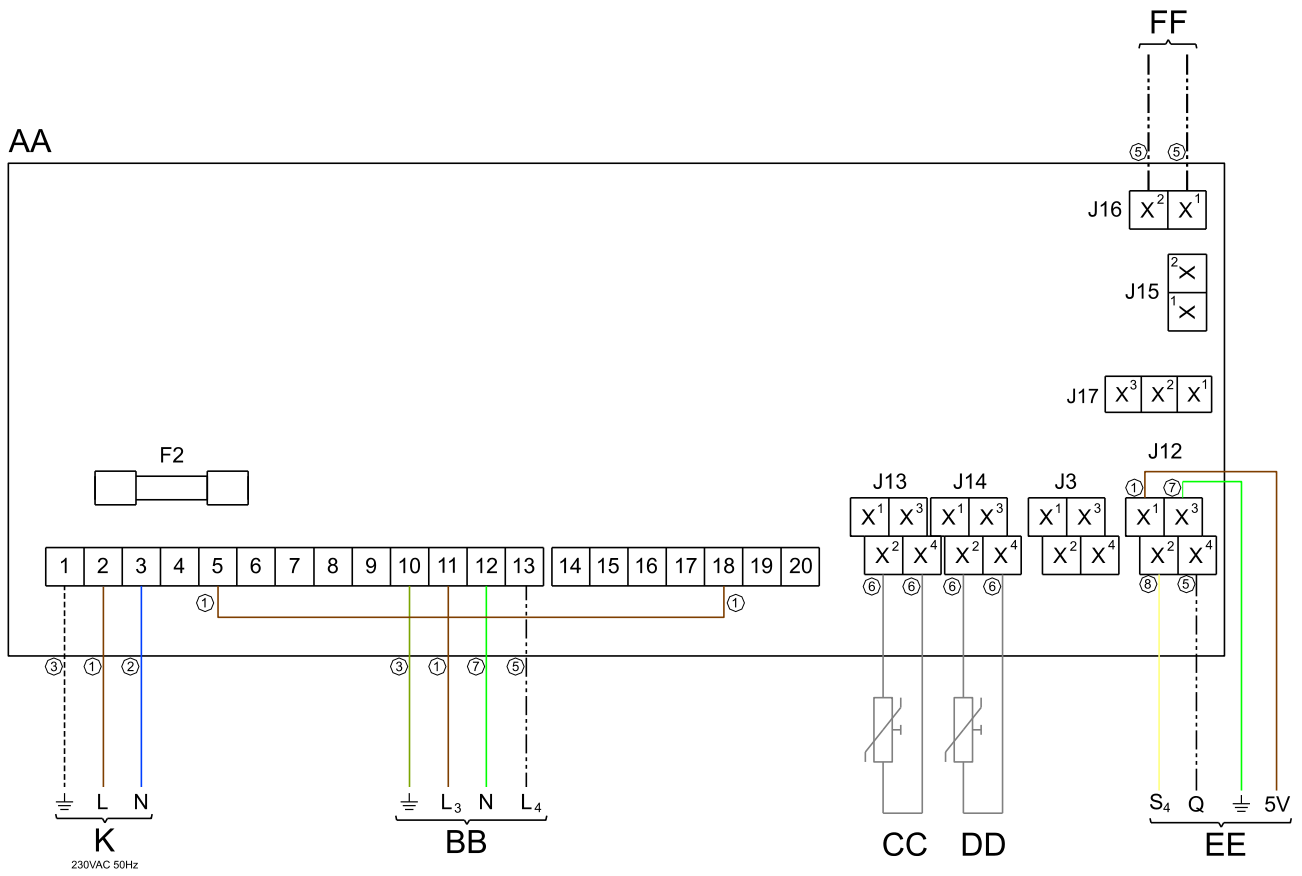

1 = brown, 2 = blue, 3 = yellow / green, 4 = black, 5 = white, 6 = grey / beige, 7 = green, 8 = yellow

TERMINAL BLOCK CONNECTIONS

\perp	Earth
N	Neutral
L	Live input of the controller
L ₃	Live input for the solar heating system modulating pump
L ₄	Modulating output of the solar heating system modulating pump

COMPONENTS

AA	Controller
BB	Solar heating system pump (modulating)
CC	Temperature sensor (S ₁ - solar collector)
DD	Temperature sensor (S ₂ - tank)
EE	Combined Q/T sensor (incl. temperature sensor S ₄ - solar collector return)
FF	Communication between the water heater controller and the solar Heating system controller (BUS-link)
K	Double-pole isolator

CONTROLLER CONNECTIONS

J12	Connection of combined Q/T sensor (1-2-3-4)
J13	Connection of temperature sensor S ₁ (2-4)
J14	Connection of temperature sensor S ₂ (2-4)
J16	Connection of BUS-link communication
F2	Fuse (T 3.15A - 250 V)

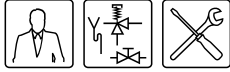

Read this manual carefully

Warning

Read this manual carefully before starting the water heater. Failure to read the manual and to follow the printed instructions may lead to personal injury and damage to the water heater.

Copyright © 2013 A.O.Smith Water Products Company

All rights reserved.

Nothing from this publication may be copied, reproduced and/or published by means of printing, photocopying or by whatsoever means, without the prior written approval of A.O.Smith Water Products Company.

A.O.Smith Water Products Company reserves the right to modify specifications stated in this manual.

Trademarks

Any brand names mentioned in this manual are registered trademarks of their respective owners.

Liability

A.O.Smith Water Products Company accepts no liability for claims from third parties arising from unauthorised use, use other than that stated in this manual, and use other than in accordance with the General Conditions registered at the Chamber of Commerce.

Refer further to the General Conditions. These are available on request, free of charge.

Although considerable care has been taken to ensure a correct and suitably comprehensive description of all relevant components, the manual may nonetheless contain errors and inaccuracies.

Should you detect any errors or inaccuracies in the manual, we would be grateful if you would inform us. This helps us to further improve our documentation.

More information

If you have any comments or queries concerning specific aspects related to the water heater, then please do not hesitate to contact:

A.O.Smith Water Products Company

PO Box 70

5500 AB Veldhoven

The Netherlands

Telephone: 0870-AOSMITH
0870-2676484

General: +31 40 294 25 00

Fax: +31 40 294 25 39

E-mail: info@aosmith.nl

Website: www.aosmith.co.uk

In the event of problems with your gas, electricity or water supply connections, please contact the supplier/installation engineer of your installation.

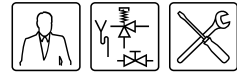



Contents

1	Introduction	9
1.1	About the water heater	9
1.2	What to do if you smell gas	9
1.3	Regulations	9
1.4	Target groups	10
1.5	Maintenance	11
1.6	Notation conventions	11
1.7	Overview of this document	12
2	Working principle of the water heater	13
2.1	Introduction	13
2.2	General working principle of the water heater	13
2.3	Water heater operating cycle	14
2.4	Protection for the water heater	15
2.5	Safety of the installation	16
2.6	Protection for the solar heating system	17
2.7	Safety of the solar heating system	18
3	Installation	19
3.1	Introduction	19
3.2	Packaging	19
3.3	Ambient conditions	19
3.4	Technical specifications	21
3.5	Installation diagram	25
3.6	Unvented water connections	26
3.7	Vented water connections	27
3.8	Gas connection	28
3.9	Solar heating system	28
3.10	Air supply and chimney flue discharge	29
3.11	Electrically connecting the water heater	34
3.12	Electrical connection of the solar heating system	38
3.13	Check the supply pressure, gas control valve pressure, CO ₂ value and switching pressure	40
4	Conversion to a different gas category	47
4.1	Introduction	47
5	Filling	49
5.1	Filling unvented installations	50
5.2	Filling vented installations	50
5.3	Filling solar heating system	51
6	Draining	53
6.1	Draining unvented installations	54
6.2	Draining vented installations	54
6.3	Draining solar heating system	55

Contents

7	The control panel - - - - -	57
7.1	Introduction - - - - -	57
7.2	Control - - - - -	57
7.3	Explanation of icons- - - - -	57
7.4	ON/OFF switch on controller - - - - -	57
7.5	Navigation buttons - - - - -	58
7.6	PC connection - - - - -	58
8	Status of the water heater - - - - -	59
8.1	Introduction - - - - -	59
8.2	Operating modes - - - - -	59
8.3	Error conditions - - - - -	60
8.4	Service condition - - - - -	60
8.5	Anode warning - - - - -	61
8.6	Q/T Sensor warning- - - - -	61
8.7	Collector temperature warning- - - - -	61
9	Starting the water heater - - - - -	63
9.1	Introduction - - - - -	63
9.2	Starting the appliance - - - - -	63
9.3	The appliance's heating cycle - - - - -	63
10	Shutting down - - - - -	65
10.1	Introduction - - - - -	65
10.2	Decommissioning the water heater for a short period- - - - -	65
10.3	Isolating the water heater from the mains - - - - -	65
10.4	Decommissioning the water heater for a long period - - - - -	65
11	Main menu - - - - -	67
11.1	Introduction - - - - -	67
11.2	Notation convention for menu-related instructions - - - - -	67
11.3	Switching to "ON mode"- - - - -	67
11.4	Setting the water temperature - - - - -	67
11.5	Week program - - - - -	68
11.6	Starting and stopping the week program - - - - -	68
11.7	Changing the appliance's standard week program - - - - -	68
11.8	Adding times to a week program- - - - -	70
11.9	Deleting times from a week program- - - - -	71
11.10	Extra period- - - - -	72
11.11	Settings- - - - -	73
12	Service program - - - - -	75
12.1	Introduction - - - - -	75
12.2	Setting the hysteresis - - - - -	75
12.3	Displaying the error history - - - - -	75
12.4	Displaying the water heater history - - - - -	76
12.5	Display the selected water heater - - - - -	76
12.6	Switching the pump on or off - - - - -	76
12.7	Setting the service interval - - - - -	76
12.8	Service mode - - - - -	76
12.9	Setting legionella prevention- - - - -	77
12.10	Solar heating system configuration - - - - -	78
12.11	Setting the central heating configuration - - - - -	79

13	Errors - - - - -	81
13.1	Introduction - - - - -	81
13.2	Troubleshooting table for general errors - - - - -	82
13.3	Troubleshooting table for displayed errors - - - - -	85
13.4	Warnings on the display - - - - -	94
14	Service interval - - - - -	97
14.1	Introduction - - - - -	97
14.2	Determining service interval - - - - -	97
15	Performing maintenance - - - - -	99
15.1	Introduction - - - - -	99
15.2	Preparation for maintenance - - - - -	99
15.3	Water-side maintenance - - - - -	100
15.4	Gas-side maintenance - - - - -	101
15.5	Solar collector maintenance - - - - -	102
15.6	Finalizing maintenance- - - - -	102
16	Warranty (certificate) - - - - -	103
16.1	General warranty - - - - -	103
16.2	Tank warranty - - - - -	103
16.3	Collector warranty - - - - -	103
16.4	Conditions for Installation and use - - - - -	103
16.5	Exclusions - - - - -	104
16.6	Scope of the warranty - - - - -	104
16.7	Claims- - - - -	104
16.8	Obligations of A.O.Smith - - - - -	104
17	Appendices - - - - -	105
17.1	Introduction - - - - -	105
17.2	Menu structure- - - - -	106
17.3	Electrical diagram for the appliance- - - - -	108
17.4	Electrical diagram, solar heating system - - - - -	110
17.5	Declaration of conformity- - - - -	112
17.6	Week program card - - - - -	113

Contents



1 Introduction

1.1 About the water heater

This manual describes how to install, service and use the SGE water heater. The SGE water heater is a condensing boiler with a fan in the air intake. The water is heated partly by means of an external heat exchanger that can be connected to e.g. a solar energy source.

The SGE can be installed as either an open or room-sealed water heater. A concentric chimney connector is fitted standard to the water heater, but a parallel system can also be connected.

The possible installation types are B23, C13, C33, C43, C53 and C63.

The information in this manual applies to the: SGE 40 and SGE 60.

The water heater has been manufactured and equipped in accordance with the European standard for gas-fired storage water heaters for the production of domestic hot water (EN 89). The water heaters are therefore compliant with the European Directive for Gas water heaters, and are entitled to bear the CE mark.



Warning

Read this manual carefully before starting the water heater. Failure to read the manual and to follow the printed instructions may lead to personal injury and damage to the water heater.

1.2 What to do if you smell gas

Warning

If you **smell gas**:

No naked flames! No smoking!

Avoid causing sparks! Do not use any electrical equipment or switch, i.e. no telephones, plugs or bells!

Open windows and doors!

Shut off the mains gas supply valve!

Warn occupants and leave the building!

After leaving the building, alert the gas distribution company or your installation engineer.

1.3 Regulations

Gas Safety (installations and Use) Regulations 1998 (as amended). It is law that all gas appliances are installed by competent persons, in accordance with the above regulations. Failure to install appliances correctly could lead to prosecution. It is in your own interest and that of safety, to ensure that this law is complied with.

The installation of the water heater **MUST** be in accordance with the relevant requirements of the Gas Safety Regulations, Building Regulations, IEE Regulations and the Water Supply (water fittings) Regulations.

The installation should also be in accordance with any relevant requirements of the HSE, local gas region and local authority and the relevant recommendations of the following documents:

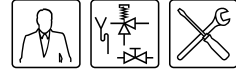

British and European Standards

- **BS 6891:**
Installation of low pressure gas pipework of up to 35 mm (R1¼) in domestic premises (2nd family gas) - Specification. Note: for larger installations see IGE/UP/2 below.
- **BS 6798:**
Specification for installation and maintenance of gas-fired boilers of rated input not exceeding 70 kW net.
- **BS 6644:**
Specification for installation of gas-fired hot water boilers of rated inputs between 70 kW (net) and 1.8 MW (net) (2nd and 3rd family gases).
- **BS 6700:**
Design, installation, testing and maintenance of services supplying water for domestic use within buildings and their cartilages - Specifications
- **BS EN 806-2:**
Specification for installations inside buildings conveying water for human consumption. Part 2: Design.
- **BS 5546:**
Specification for installation of hot water supplies for domestic purposes, using gas-fired appliances of rated input not exceeding 70 kW.
- **BS 5440:**
Flueing and ventilation for gas appliances of rated input not exceeding 70 kW net (1st, 2nd and 3rd family gases).
Part 1: Specification for installation of gas appliances to chimneys and for maintenance of chimneys.
Part 2: Specification for installation and maintenance of ventilation for gas appliances.

Institute of Gas Engineers and Managers (IGEM) Publications

- **IGE/UP/1:**
Soundness testing and purging of industrial and commercial gas installations.
- **IGE/UP/1A:**
Soundness testing and direct purging of small low pressure industrial and commercial natural gas installations.
- **IGE/UP/2:**
Gas installation pipework, boosters and compressors on industrial and commercial premises.
- **IGE/UP/10:**
Installation of flued gas appliances in industrial and commercial premises.

CIBSE Publications

- **Guide G:** Public Health Engineering.

1.4 Target groups

The three target groups for this manual are:

- (end) users;
- installation engineers;
- service and maintenance engineers.

Symbols on each page indicate the target groups for whom the information is intended. See the table.



Target group symbols

Symbol	Target Group
	(End) user
	Installation engineer
	Service and maintenance engineer

Caution

This water heater is not intended for use by persons with reduced physical, sensory or mental capacities, or who lack the necessary experience or knowledge, unless the person responsible for their safety is supervising them or has explained to them how the water heater should be used.

Caution

This water heater is not intended to be used by children. Always supervise children, and ensure that they do not play with the water heater.

1.5 Maintenance

A service should be carried out at least once a year, both on the water side and on the gas side. Among other things, the service interval depends on the water quality, the average burning time per day and the set water temperature.

Note

To determine the correct service interval, it is recommended to arrange for the service and maintenance engineer to check the water heater on both the water and gas side within three months following installation. Based on this check, the best service interval can be determined.

Note

Regular maintenance extends the service life of the water heater.

Both the end user and the service and maintenance engineer are responsible for regular maintenance. They will need to establish clear agreements on this.

Note

If the water heater is not regularly serviced, the warranty will become void.

1.6 Notation conventions

The following notation is used in this manual:

Note

Important information.

Caution







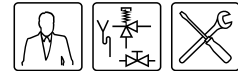

































Ignoring this information can lead to the water heater being damaged.

Warning

Failure to carefully read this information may lead to danger of personal injury, and serious damage to the water heater.



1.7 Overview of this document

Chapter	Target groups	Description
<u>Working principle of the water heater</u>	  	This chapter describes the working principle of the water heater.
<u>Installation</u>	 	This chapter describes the installation activities to be carried out before final commissioning.
<u>Conversion to a different gas category</u>	 	This chapter describes the activities required to convert the water heater to a different gas category.
<u>Filling</u>	  	This chapter describes how to fill the water heater.
<u>Draining</u>	  	This chapter describes how to drain the water heater.
<u>The control panel</u>	  	This chapter describes the general control of the water heater using the display.
<u>Status of the water heater</u>	  	This chapter describes the status (mode or condition) that the water heater may have, and possible actions to take.
<u>Starting the water heater</u>	  	This chapter describes how to start the water heater. The general operating cycle of the water heater is also described.
<u>Shutting down</u>	  	This chapter describes how to decommission the water heater for a brief or long period of time.
<u>Main menu</u>	  	This chapter describes the main menu of the display. This is the actual menu for the user. However, the installation engineer and service and maintenance engineers will also need to use this menu.
<u>Service program</u>	 	This chapter describes the service menu. It is mainly intended for the installation engineer and service and maintenance engineers. End users may also refer to this chapter for additional information about the water heater.
<u>Errors</u>	  	This chapter is mainly intended for the installation engineer and the service and maintenance engineer. It describes water heater errors. These errors are reported on the display. A troubleshooting table of possible causes and solutions is provided. End users may also refer to this chapter for additional information about the water heater.
<u>Service interval</u>	 	<p>This chapter describes how to determine the optimum service interval (frequency of regular maintenance). Both the end user and the service and maintenance engineer are responsible for regular maintenance. They need to reach clear agreement on this.</p> <hr/> <p>Note  If the water heater is not regularly serviced, the warranty will become void.</p>
<u>Performing maintenance</u>		This chapter sets out the maintenance tasks to be carried out.
<u>Warranty (certificate)</u>	  	This chapter states the warranty terms and conditions.

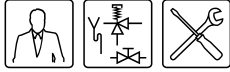

2 Working principle of the water heater

2.1 Introduction

This chapter covers the following topics:

- General working principle of the water heater;
- Water heater operating cycle;
- Protection for the water heater;
- Safety of the installation;
- Protection for the solar heating system;
- Safety of the solar heating system.

2.2 General working principle of the water heater

The water heater is fitted with a modulating premix burner system with 1:1 gas-to-air ratio regulation. The air required for combustion is delivered by the fan (18). The gas is supplied via the gas control valve (16) and the venturi (30) on the intake side of the fan. The 1:1 gas-to-air ratio always guarantees the most efficient gas/air mixture.

In this water heater, the cold water enters the bottom of the tank through the cold water inlet (14). The water is heated by means of a heat exchanger (55) connected to a solar heating system and a gas-fired heat exchanger (11).

The heated tap water leaves the tank through the hot water outlet (2). Once the water heater is completely filled with water, it will constantly be under mains water pressure. As hot water is drawn from the water heater, cold water is immediately added.

The special design of the heat exchanger (11) ensures that the flue gases are first led downwards via the combustion chamber, then upwards via the heat exchanger, and downwards again alongside the water in the tank. The flue gases gradually become cooler in the process. Because the cooled flue gases flow alongside the cold water lower down in the tank, they start to condense. This condensation causes latent heat energy to be transferred to the cooler water, thereby increasing the performance of the unit. The condensate yielded by this process is discharged via the condens trap (23).

The insulation layer (24) prevents heat loss. The inside of the tank is enamelled to protect against corrosion. The anodes (9) provide extra protection against corrosion.

The water heater has an inspection and cleaning opening (12) for maintenance.

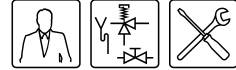

Cut-away view of the water heater

Legend

Unused numbers are not applicable

1. cover
2. hot water outlet
3. electrical connector block
4. controller
5. pressure switch
6. control panel
7. temperature sensor T_1
8. combustion chamber
9. anode
10. tank
11. heat exchanger
12. inspection and cleaning opening
13. temperature sensor T_2
14. cold water inlet
15. drain valve
16. gas control valve
17. burner
18. fan
19. air supply hose
20. hot surface igniter
21. flame probe
22. chimney pipe
23. condens trap
24. insulation layer
29. base
55. heat exchanger (e.g. solar heating system)
56. temperature sensor S_2
58. flue gas test nipple
59. pressure-reducing valve

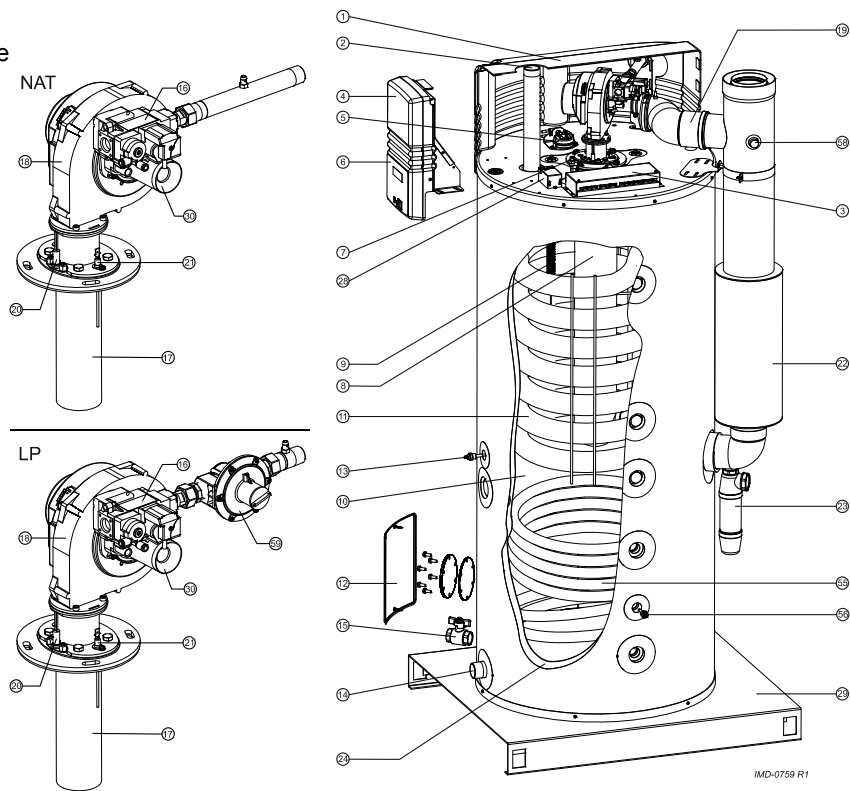

2.3 Water heater operating cycle

The water temperature (T_1) at the top of the water heater is used to control when the gas burner is started and stopped. The temperature changes in the water heater are used for switching the solar heating system on and off (using T_1 and S_2). T_1 is the curve shown in the figure. In addition, temperatures S_1 and S_2 are used by the solar heating system controller. Temperature S_1 is measured in the solar collector and S_2 between the inlet and outlet of the heat exchanger (55).

The other settings that govern the control behaviour are:

- T_{set}
 T_{set} is the the required water temperature that has been set on the appliance (11.4.1 "Setting the water temperature via the SET POINT MENU"). As soon as T_1 falls below T_{set} , the solar heating system starts heating the water, but only if the temperature of the heating fluid (S_1) is greater than the temperature measured at the appliance (sensor S_2) by a given (adjustable) amount. When $T_1 = T_{set} = T_{solar\ limit}$, heating by the solar heating system stops. There is one exception to this rule, which is when $T_{solar\ limit}$ is set to a higher value than T_{set} .

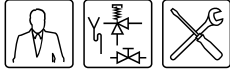

- **Hysteresis**
The moment that T_1 falls below $(T_{\text{set}} - T_{\text{solar diff}} - \text{hysteresis})$, the controller registers such a heat demand that the gas burner and the solar heating system jointly heat the water. The solar heating system is only employed when the temperature measured by S_1 is a certain (adjustable) value greater than that of S_2 .
- $T_{\text{solar diff}}$
When T_{net} exceeds $(T_{\text{set}} - T_{\text{solar diff}})$, the gas burner is shut off and the water is heated by the solar heating system alone. When T_1 rises above T_{set} (provided that $T_{\text{set}} = T_{\text{solar limit}}$), the solar heating system is switched off. The value of $T_{\text{solar diff}}$ is adjustable ([12.10.4 "Setting the solar difference"](#)).
- $T_{\text{solar limit}}$
Preset ([12.10.3 "Setting the solar limit"](#)) water temperature at which heating via the solar heating system is stopped.

Graphical representation of operating cycle

Legend

A = Gas burner on
B = Gas burner off

T_1 :

- = No heat demand, so water is not heated
- — = Water heated via solar heating system
- - - - = Water heated via solar heating system and gas burner

t = time

T = Temperature

45 °C = Minimum tap water temperature

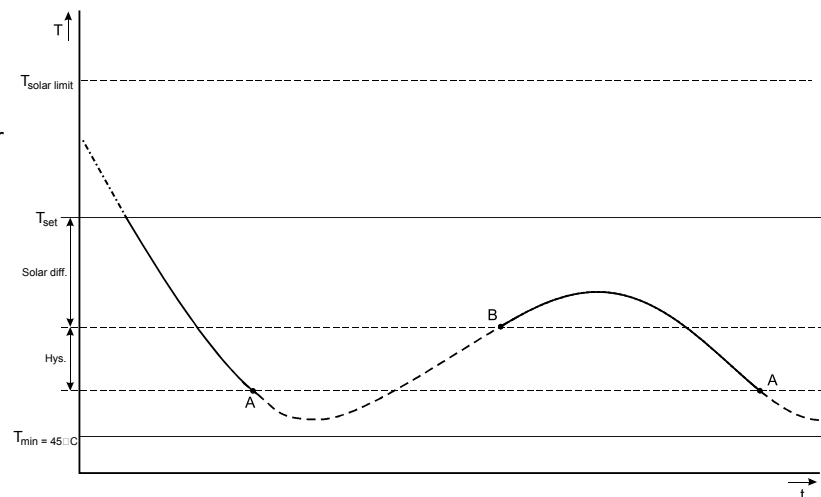

Note

T_1 can rise above T_{set} . However, this is only possible if $T_{\text{solar limit}}$ is increased via the service menu.

2.4 Protection for the water heater

2.4.1 Introduction

The controller monitors the water temperature, helps ensure the safe use of the solar heating system, and ensures safe combustion. This takes place using:

- the [Water heater water temperature protection](#)
- the [Gas control valve](#)
- the [Fan](#)
- the [Pressure switch](#)
- the [Flame probe](#)

2.4.2 Water heater water temperature protection

The controller (4) controls and monitors the safety of the water heater by means of sensors T_1 and T_2 . S_2 is also used for protection of the water heater. However, this is primarily intended for control of the solar heating system ([2.6 "Protection for the solar heating system"](#)).

The table explains the functioning of these temperature sensors.

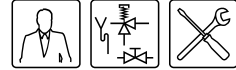

Temperature protection

protection	Description
Against frost: - $T_1 < 5^\circ\text{C}$ - $T_2 < 5^\circ\text{C}$	The frost protection cuts in. The water is heated to 20°C .
Against overheating of water: - $T_1 > 88^\circ\text{C}$ - $T_2 > 88^\circ\text{C}$ - $S_2 > 88^\circ\text{C}$	The high-limit safeguard serves to prevent overheating and/or excessive formation of scale in the water heater. If the high-limit safeguard is activated, the heating is stopped. This causes the water in the tank to cool down. Once the water has cooled sufficiently ($T_1 < 81^\circ\text{C}$), the controller resets the water heater.
For extra safety: - $T_1 > 93^\circ\text{C}$ - $T_2 > 93^\circ\text{C}$ - $S_2 > 93^\circ\text{C}$	A lockout error of the water heater controller takes place. The controller must be manually reset before the water heater can resume operation (8.3 "Error conditions"). The reset may only be performed once $T_1 < 81^\circ\text{C}$.

2.4.3 Gas control valve

The controller opens the gas control valve so that gas can be supplied to the burner. As a safety measure, the gas control valve has two valves. Both valves shut off the gas supply.

2.4.4 Fan

The fan (18) provides an optimum air supply when there is a heat demand. As a safety feature, the fan ensures that any gases present in the combustion chamber are removed, both before and after combustion. We refer to this as pre- and post-purge.

The fan speed is continuously monitored by the controller (4). The controller takes control if the fan rpm varies too much from the value set.

2.4.5 Pressure switch

The pressure switch only guarantees the supply of air during pre-purging of the water heater. If the pressure difference during pre-purging is sufficient, the pressure switch closes. The table ([3.4.2 "General and electrical specifications"](#)) shows the trip point for each water heater.

Note

The trip point of the pressure switch is not adjustable.

2.4.6 Flame probe

To ensure that no gas can flow when there is no combustion, the water heater is fitted with a flame probe (21). The controller uses this probe to detect the presence of a flame, by means of ionisation detection. The controller closes the gas control valve the instant it detects that there is a gas flow but no flame.

2.5 Safety of the installation

Excessive pressure in the tank can damage the enamelled layer (in the water heater) or the tank itself. An inlet combination and pressure-reducing valve prevents this. The inlet combination acts as a stop valve, non-return valve and overflow valve. If the water mains pressure is too high ([3.4.2 "General and electrical specifications"](#)), a pressure-reducing valve must be used. Both components must be fitted in the cold water inlet ([3.7 "Vented water connections"](#)).

The use of an expansion vessel, expansion valve and/or pressure reducing valve depends on the type of installation: unvented or vented.

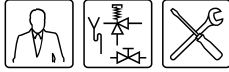

2.5.1 Unvented installation

With an unvented installation, an expansion valve and expansion vessel prevent the buildup of excessive pressure in the tank. This prevents damage being caused to the enamel coating (in the water heater) or to the tank. A non-return valve prevents excessive pressure build-up in the water supply system. This valve also prevents water from flowing backwards from the tank into the cold water supply system. The pressure-reducing valve protects the water heater against excess mains water pressure ([3.4.2 "General and electrical specifications"](#)). These components are installed in the cold water inlet ([3.7 "Vented water connections"](#)).

2.5.2 Vented installation

With a vented installation, excess pressure is taken up by the open cold water head tank. The level of the cold water head tank determines the maximum working pressure ([3.4.2 "General and electrical specifications"](#)) in the tank. The water heater must also be fitted with a vent pipe from the hot water pipe, which opens into the cold water head tank.

Ideally, the vent pipe should discharge into a separate discharge channel/drain or otherwise to the open cold water head tank. The water heater should also be fitted with a stop valve ([3.6.2 "Hot water side"](#)) on the hot water side.

2.5.3 T&P valve

A T&P valve is only mandatory in unvented installations. However, A.O.Smith also recommends the use of a T&P valve in vented installations.

A T&P (Temperature and Pressure Relief) valve monitors the pressure in the tank and the water temperature at the top of the tank. If the pressure in the tank becomes too high ([3.4.2 "General and electrical specifications"](#)), the valve will open. The hot water can now flow out of the tank. Because the water heater is under water supply pressure, cold water will automatically flow into the tank. The valve remains open until the unsafe situation has been rectified. The water heater is fitted standard with a connection for a T&P valve ([3.6.2 "Hot water side"](#)).

2.6 Protection for the solar heating system

2.6.1 Drain-back tank

The solar heating system may optionally be equipped with a drain-back tank. The tank fills itself with the heating fluid when there is no heat demand. This avoids overheating of the solar heating system. The high insulation factor of the tank also protects the system against freezing of the fluid. The use of the drain-back tank also serves to extend the useful life of the fluid.

The existence of a drain-back tank is set ([12.10.1 "Setting the drain-back tank"](#)) during the installation. Refer to the solar heating system manual for more details.

2.6.2 Fluid temperature

The heat exchanger of the solar heating system is filled with glycol. If the temperature of the heating fluid is too high, a signal is sent to the controller of the solar collector and the pump of the solar collector is switched off. This signal is passed to the controller by temperature sensor S_1 .

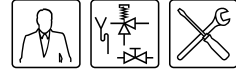

Temperature protection for solar heating system

Protection	Description
Maximum temperature: - $S_1 > 130^\circ\text{C}$	The pump of the solar heating system switches off when the temperature of the heating fluid at S_1 exceeds the maximum value. The solar heating system enters error mode. The error is also visible on the display of the SGE water heater

2.7 Safety of the solar heating system

2.7.1 Expansion vessel

The solar heating system must be equipped with an expansion vessel. An expansion vessel serves to limit pressure variations in the system. The expansion vessel in the solar heating system can withstand a maximum pressure of 600 kPa (6 bar). The supply pressure to the expansion vessel depends on the static head of the system.

The system is protected from overpressure by an expansion valve (2.7.1 "Expansion vessel") as well as the expansion vessel.

2.7.2 Expansion valve

The solar heating system is equipped with an expansion valve. The expansion valve monitors the pressure in the solar heating system. Should the pressure become higher than 600 kPa (6 bar), the valve will open. The hot water can now flow out of the installation. The valve remains open until the unsafe situation has passed, i.e. until the pressure has fallen back to below 600 kPa (6 bar).

Note

Because a closed system is pressurized and is not filled automatically, the system will have to be filled (5 "Filling") again when the expansion valve has been activated. A system with a drain-back tank is not pressurized and does not have an expansion valve.



3 Installation

Warning

The installation must be carried out by an approved installation engineer in compliance with the general and local regulations imposed by the gas, water and power supply companies and the fire brigade.

The appliance may only be installed in a room that complies with the requirements stated in national and local ventilation regulations ([1.3 "Regulations"](#)).

3.1 Introduction

This chapter describes the installation activities to be carried out before final commissioning ([9 "Starting the water heater"](#)), namely:

- [Packaging](#);
- [Ambient conditions](#);
- [Technical specifications](#);
- [Installation diagram](#);
- [Unvented water connections](#);
- [Vented water connections](#);
- [Gas connection](#);
- [Air supply and chimney flue discharge](#);
- [Solar heating system](#);
- [Electrically connecting the water heater](#);
- [Electrical connection of the solar heating system](#);
- [Check the supply pressure, gas control valve pressure, CO₂ value and switching pressure](#).

For possible conversion to a different gas category, see conversion ([4 "Conversion to a different gas category"](#)).

3.2 Packaging

To avoid damaging the water heater, remove the packaging carefully.

We recommend unpacking the water heater at or near its intended location.

Caution

The water heater may only be manoeuvred in an upright position. Take care that the water heater is not damaged after unpacking.

3.3 Ambient conditions

The water heater is suitable for either open or room-sealed combustion. If installed as a room-sealed water heater, it is independent of the installation site for the necessary external air supply. In this event, there are no additional ventilation requirements.

If the water heater is to be installed as an open system, it must meet the locally-applicable directives and ventilation regulations for open water heaters.

The possible installation types are B23, C13, C33, C43, C53 and C63.

Caution

The water heater may not be used in rooms where chemical substances are stored or used due to the risk of explosion, and corrosion of the water heater. Some propellants, bleaching agents and degreasing agents etc. disperse vapours that are explosive and/or cause accelerated corrosion. If the water heater is used in a room in which such substances are present, the warranty will be void.

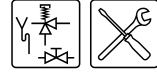

3.3.1 Air humidity and ambient temperature

The boiler room must be frost-free, or be protected against frost. The table shows the ambient conditions that must be adhered to for correct functioning of the electronics present in the appliance to be guaranteed.

Air humidity and ambient temperature specifications

Air humidity and ambient temperature	
Air humidity	max. 93% RH at +25°C
Ambient temperature	functionality: $0 \leq T \leq 60^\circ\text{C}$

3.3.2 Water heater maximum floor load

Allow for the water heater's weight and the maximum floor load; refer to the table (3.4.2 "General and electrical specifications").

3.3.3 Water composition

The appliance is intended for heating drinking water. The drinking water must comply with the regulations governing drinking water for human consumption. The table gives an overview of the specifications.

Water specifications

Water composition	
Hardness (alkaline earth ions)	> 1.00 mmol/l: <ul style="list-style-type: none"> • German hardness > 5.6° dH • French hardness > 10.0° fH • English hardness > 7.0° eH • $\text{CaCO}_3 > 100 \text{ mg/l}$
Conductivity	> 125 $\mu\text{S/cm}$
Acidity (pH value)	$7.0 < \text{pH value} < 9.5$

Note

If the water specifications deviate from those stated in the table, then the tank protection cannot be guaranteed (16 "Warranty (certificate)").

3.3.4 Working clearances

For access to the water heater, it is recommended that the following clearances are observed (see figure):

- AA: around the water heater's control column and cleaning openings: 100 cm.
- BB: all sides of the water heater: 50 cm.
- Top of the water heater: 100 cm



Working clearances

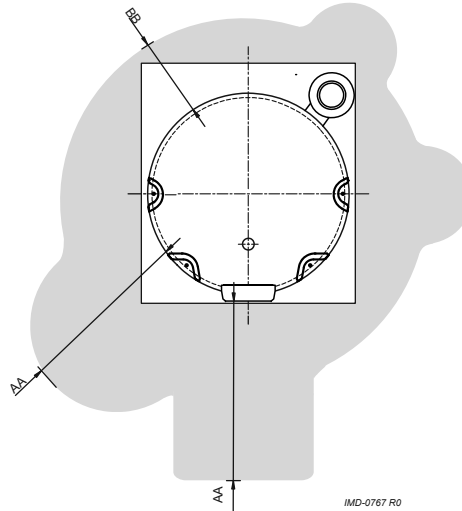

3.4 Technical specifications

The water heater is supplied without accessories. Check the dimensions (3.4 "Technical specifications"), gas data (3.4.3 "Gas data") and other specifications (3.4.2 "General and electrical specifications") of any accessories you plan to use.

3.4.1 Dimensions of the water heater

Plan and elevation of the water heater

Legend

See the table.

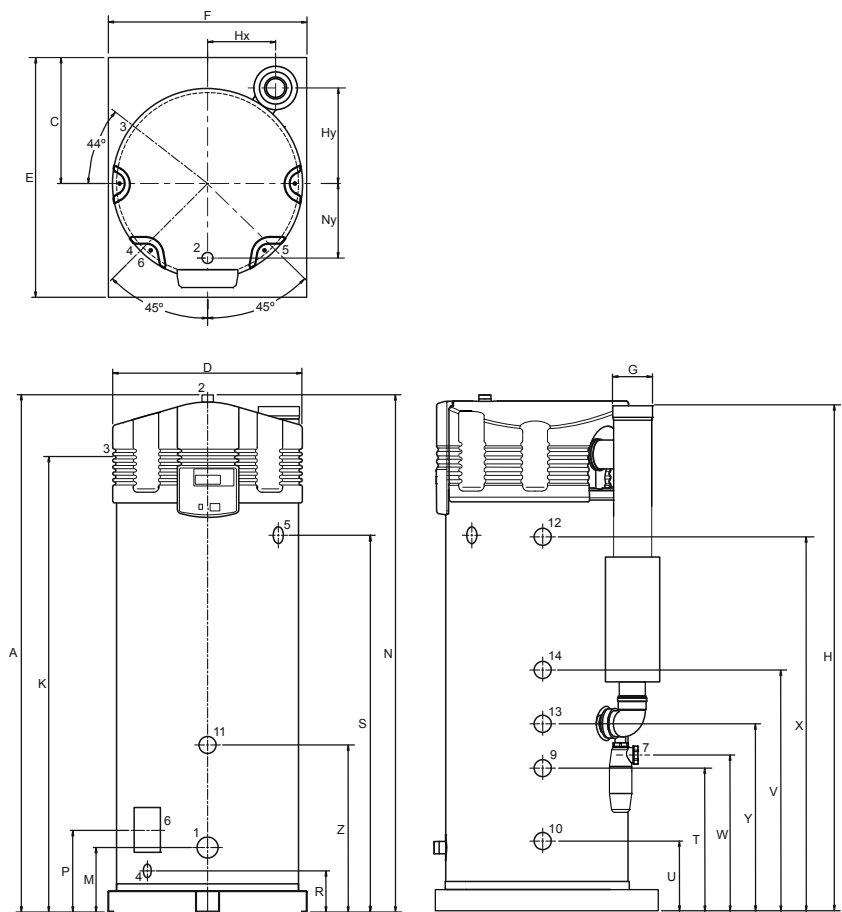

IMD-0772 R0

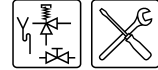

Size	Description	Unit	SGE 40	SGE 60
A	Overall height	mm	2055	2055
C	Position on pallet	mm	490	490
D	Appliance diameter	mm	705	705
E	Depth	mm	925	925
F	Width	mm	850	850
G	Diameter of flue gas discharge	mm	100 / 150	100 / 150
H	Height of chimney flue	mm	1995	1995
Hx	x position flue gas outlet	mm	260	260
Hy	y position flue gas outlet	mm	370	370
K	Height of gas/burner connection	mm	1960	1960
M	Height of cold water supply	mm	185	185
N	Height of hot water outlet	mm	2055	2055
Ny	y position of hot water outlet	mm	205	205
P	Height of cleaning opening	mm	365	365
R	Height of drain valve connection	mm	180	180
S	Height of T&P valve connection	mm	1555	1555
T	Height of coil inlet	mm	630	630
U	Height of coil outlet	mm	305	305
V	Height of recirculation connection	mm	1035	1035
W	Height of condensation drain	mm	765	765
X	Height of heat exchanger supply	mm	1465	1465
Y	Height of heat exchanger discharge	mm	855	855
Z	Height of electric element connection	mm	755	755
1	Cold water supply connection (external)	-	R 1 ¹ / ₂	R 1 ¹ / ₂
2	Hot water outlet (male)	-	R 1 ¹ / ₂	R 1 ¹ / ₂
3	Gas control valve connection (external)	-	R 3 ³ / ₄	R 3 ³ / ₄
4	Drain valve connection (internal)	-	3 ³ / ₄ "	3 ³ / ₄ "
5	T&P valve connection (female)	-	1" - 11.5 NPT	1" - 11.5 NPT
6	Cleaning/inspection opening	mm	95 x 70	95 x 70
7	Condensation drainage connection (female)	-	Ø 40	Ø 40
9	Coil inlet connection (female)	-	Rp 1	Rp 1
10	Coil outlet connection (female)	-	Rp 1	Rp 1
11	Electric element connection (female)	-	Rp 1 ¹ / ₂	Rp 1 ¹ / ₂
12	Heat exchanger supply connector (female)	-	Rp 1	Rp 1
13	Heat exchanger outlet connector (female)	-	Rp 1	Rp 1
14	Recirculation connection (female)	-	Rp 1	Rp 1



3.4.2 General and electrical specifications

General and electrical specifications

Description	Unit	SGE 40	SGE 60
Contents	litres	370	370
Empty weight	kg	245	245
Maximum floor load	kg	615	615
Maximum operating pressure (vented)	kPa (bar)	800 (8)	800 (8)
Maximum operating pressure, unvented	kPa (bar)	550 (5,5)	550 (5,5)
Control thermostat adjustment range	°C	40...80	40...80
Control thermostat and default value	°C	65	65
Adjustment range for hysteresis downwards	°C	2...12	2...12
Default value for hysteresis downwards	°C	5	5
Adjustment range for solar differential	°C	0...8	0...8
Solar differential default value	°C	3	5
Adjustment range for solar limit	°C	65...80	65...80
Solar limit default value	°C	65	65
Number of (electrical) anodes	-	2	2
Observed pressure differential across the pressure switch	Pa	≥ 165	≥ 165
Pressure differential to open the pressure switch	Pa	≤ 115	≤ 115
Heating time $\Delta T = 45^{\circ}\text{C}$	at least	15	11

Description	Unit	SGE 40	SGE 60
Electrical power consumption of the appliance	W	60	120
Electrical power consumption of the solar controller	W	max. 700	max. 700
Supply voltage (-15% +10% V _{AC})	volts	230	230
Mains frequency ($\pm 1\text{Hz}$)	Hz	50	50
IP class	-	IP 20	IP 20

Description	Unit	Value
Maximum mains pressure of cold water supply (vented)	kPa (bar)	800 (8)
Maximum mains pressure of cold water supply (unvented)	kPa (bar)	500 (5,5)
Maximum mains pressure of the protected cold supply setup	kPa (bar)	500 (5)
T&P overflow pressure	kPa (bar)	700 (7)
T&P overflow temperature	°C	97

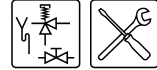

3.4.3 Gas data

Gas data

Il ₂ H ₃ P description	Unit	SGE 40	SGE 60
Gas category 2H: G20 - 20 mbar			
Venturi injector diameter	mm	-	-
Nominal load (gross)	kW	44,4	63,3
Nominal output	kW	42,8	60,4
Supply pressure	mbar	20	20
CO ₂ (full load)	Vol%	9,0 ± 1,0	9,0 ± 1,0
Gas consumption (*)	m ³ /h	4,2	6,0
Gas category 3P: G31 - 37/50 mbar			
Venturi injector diameter	mm	6,00	6,00
Nominal load (gross)	kW	43,5	62,0
Nominal output	kW	42,8	60,4
Supply pressure	mbar	37 / 50	37 / 50
Gas control valve pressure	mbar	12,0 ± 2,0	12,0 ± 2,0
CO ₂ (full load)	Vol%	10,0 ± 1,0	10,0 ± 1,0
Gas consumption (*)	kg/h	3,1	4,4
(*) Based on 1013.25 mbar and 15°C.			

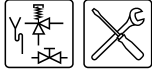

3.5 Installation diagram

The figure shows the Installation diagram. This diagram is referred to in the sections describing the actual connection procedure.

Installation diagram

Legend Vented and unvented

Unused numbers are not applicable

1. pressure reducing valve (mandatory)
3. T&P valve (mandatory)
4. stop valve (recommended in pipe C and mandatory in pipe A)
5. non-return valve (mandatory)
6. circulation pump (optional)
9. drain valve (mandatory)
10. manual gas valve (mandatory)
20. pressure valve (mandatory)
26. air bleed (mandatory)
11. service stop valve (recommended)
12. temperature gauge (recommended)
13. condensation drain (mandatory)
14. draw-off points
15. expansion valve (mandatory)
16. expansion vessel (mandatory)
17. 3-way aeration valve (recommended)
18. cold water head tank
19. float switch
23. pressure valve (mandatory)
37. combined Q/T sensor (optional)
38. solar heating system pump station (modulating - mandatory)
- A. cold water supply
- B. hot water supply
- C. circulation pipe
- D. gas supply
- E. overflow pipe
- F. supply heat exchanger
- G. heat exchanger return
- H. overflow protection
- S₁. collector sensor (mandatory)
- S₂. tank sensor (mandatory)
- S₄. heat exchanger discharge sensor (optional)

UNVENTED

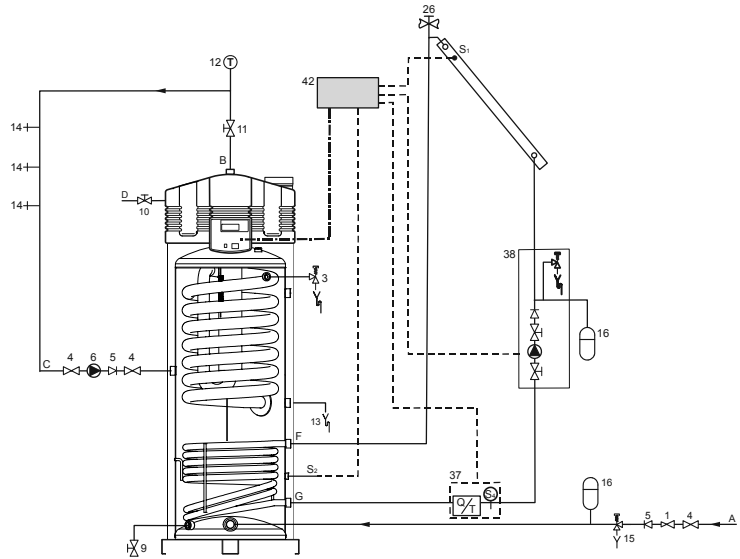

VENTED

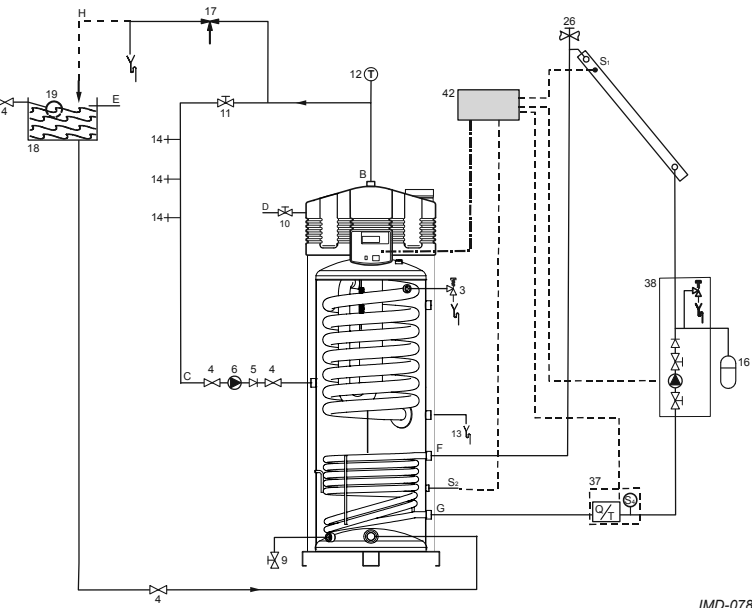

IMD-0783 R0

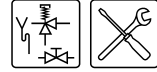
**Caution**

The installation diagram shows a pump station with an integrated non-return valve. This type of pump unit may only be used with closed systems. In systems with drain-back, installation of a pump unit with non-return valve is prohibited. There are special pump units for these systems. Please contact the pump unit supplier for this.

3.6 Unvented water connections

**Warning**

The installation should be carried out by a competent person, in compliance with general and locally applicable regulations (1.3 "Regulations").

3.6.1 Cold water side

See (A) in the installation diagram (3.5 "Installation diagram").

1. Fit an approved stop valve (4) on the cold water side as required by the applicable regulations (1.3 "Regulations").
2. The maximum working pressure of the water heater is 8 bar. Because the pressure in the water pipe at times can exceed 8 bar, you must fit an approved pressure-reducing valve (1).
3. Fit a non-return valve (5) and an expansion vessel (16).
4. Fit an expansion valve (15) and connect the overflow side to an open waste water pipe.

3.6.2 Hot water side

See (B) in the installation diagram (3.5 "Installation diagram").

**Note**

Insulating long hot water pipes prevents unnecessary energy loss.

1. Optional: fit a temperature gauge (12) so you can check the temperature of the tap water.
2. Fit the T&P valve (3).
3. Fit a stop valve (11) in the hot water outlet pipe for servicing.

3.6.3 Circulation pipe

See (C) in the installation diagram (3.5 "Installation diagram").

If an immediate flow of hot water is required at draw-off points, a circulation pump can be installed. This improves comfort, and reduces water wastage.

1. Fit a circulation pump (6) of the correct capacity for the length and resistance of the circulation system.
2. Fit a non-return valve (5) after the circulation pump to guarantee the direction of circulation.
3. Fit two stop valves for servicing (4).
4. Connect the circulation pipe according to the installation diagram (3.5 "Installation diagram").

3.6.4 Condensation drain

1. Fit a sloping waste water pipe to the condens trap (13) for condensation drainage and connect this via an open connection to the waste water discharge.

**Caution**

If the condensation drain is not fitted to the waste water discharge using an open connection, this can cause faults.



3.7 Vented water connections

Warning

The installation should be carried out by a competent person, in compliance with general and locally applicable regulations (1.3 "Regulations").

3.7.1 Cold water side

See (A) in the installation diagram (3.5 "Installation diagram").

1. Fit an approved stop valve (4) on the cold water side between the cold water head tank (18) and the water heater, as required by applicable regulations.

3.7.2 Hot water side

See (B) in the installation diagram (3.5 "Installation diagram").

Note

Insulating long hot water pipes prevents unnecessary energy loss.

1. Fit the T&P valve (3).
2. Optional: fit a temperature gauge (12) so you can check the temperature of the tap water.
3. Fit a stop valve (4) in the hot water outlet pipe for servicing.
4. If a circulation pipe is required, continue by installing the circulation pipe (3.6.3 "Circulation pipe").

3.7.3 Circulation pipe

See (C) in the installation diagram (3.5 "Installation diagram").

If an immediate flow of hot water is required at draw-off points, a circulation pump can be installed. This improves comfort, and reduces water wastage.

1. Fit a circulation pump (6) of the correct capacity for the length and resistance of the circulation system.
2. Fit a non-return valve (5) after the circulation pump to guarantee the direction of circulation.
3. Fit two stop valves for servicing (4).
4. Connect the circulation pipe according to the installation diagram (3.5 "Installation diagram").

3.7.4 Condensation drain

1. Fit a sloping waste water pipe to the condens trap (13) for condensation drainage and connect this via an open connection to the waste water discharge.

Caution

If the condensation drain is not fitted to the waste water discharge using an open connection, this can cause faults.

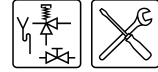

3.8 Gas connection



Warning

The installation should be carried out by a competent person, in compliance with general and locally applicable regulations ([1.3 "Regulations"](#)).



Caution

Make sure that the diameter and length of the gas supply pipe are large enough to supply sufficient capacity to the water heater.

See (D) in the installation diagram ([3.5 "Installation diagram"](#)).

1. Fit a manual gas valve (10) in the gas supply pipe.
2. Blow the gas pipe clean before use.
3. Close the manual gas valve.
4. Fit the gas supply pipe to the gas control valve.



Warning

After fitting, check for leaks.

3.9 Solar heating system



Note

Please refer to the installation diagram ([3.5 "Installation diagram"](#)), electrical diagram ([17.4 "Electrical diagram, solar heating system"](#)) and terminal block ([3.12.1 "Preparation"](#)) for details of how to connect the solar heating system.

1. Connect the supply from the solar collector to the inlet (F) of the heat exchanger.
2. Connect the return pipe to the solar collector to the outlet (G) of the heat exchanger.
3. Connect the lead to the solar heating system controller and sensor S₂, see:
 - electrical diagram ([17.4 "Electrical diagram, solar heating system"](#)) and
 - connections table ([3.11.2 "Preparation"](#)).
4. Connect the communication cable between the solar heating system controller and the water heater, see:
 - electrical diagram ([17.4 "Electrical diagram, solar heating system"](#)) and
 - connections table ([3.11.2 "Preparation"](#)).



Warning

The installation diagram shows a pump station with an integrated non-return valve. This type of pump unit may only be used with closed systems. In systems with drain-back, installation of a pump unit with non-return valve is prohibited. There are special pump units for these systems. Please contact the pump unit supplier for this.



3.10 Air supply and chimney flue discharge

3.10.1 Introduction

This section covers the following topics:

- [Requirements for flue gas discharge materials](#)
- [Concentric connections](#)
- [Parallel connections](#)

3.10.2 Requirements for flue gas discharge materials

Warning

The installation should be carried out by a competent person, in compliance with general and locally applicable regulations ([1.3 "Regulations"](#)).

Depending on the approved installation types, there are several alternatives for connecting the air supply and chimney flue.

The water heaters are approved for installations of type B23, C13, C33, C43, C53 and C63.

This manual discusses installation types C13 and C33 in detail. If the water heater has to function in accordance with B23, C43, C53 or C63, you can obtain more information by contacting A.O. Smith.

The figure and table give information about these types of installation. For an explanation of the possibilities, please contact the manufacturer.

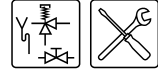

Installation types

C43

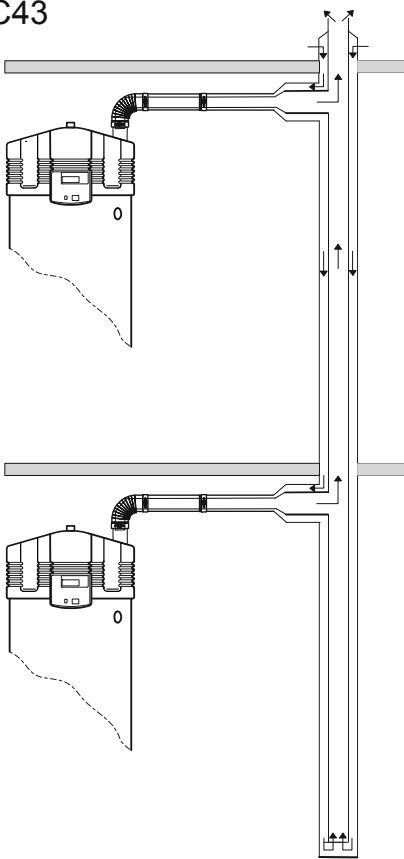

B23

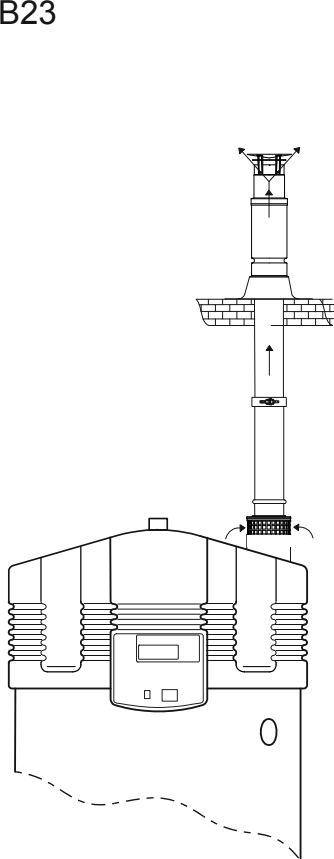

C33

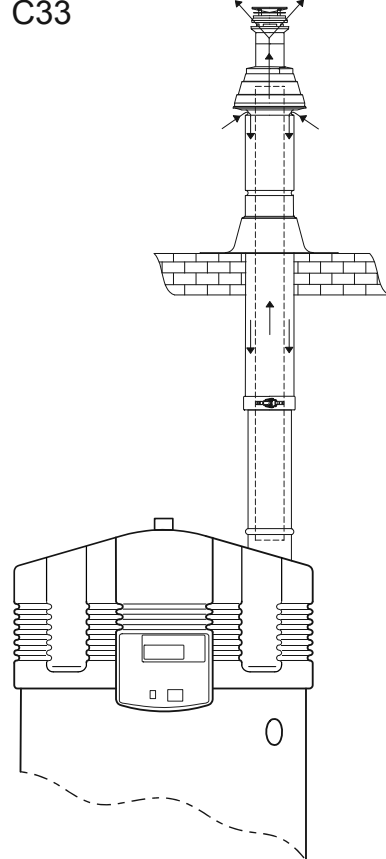

C13

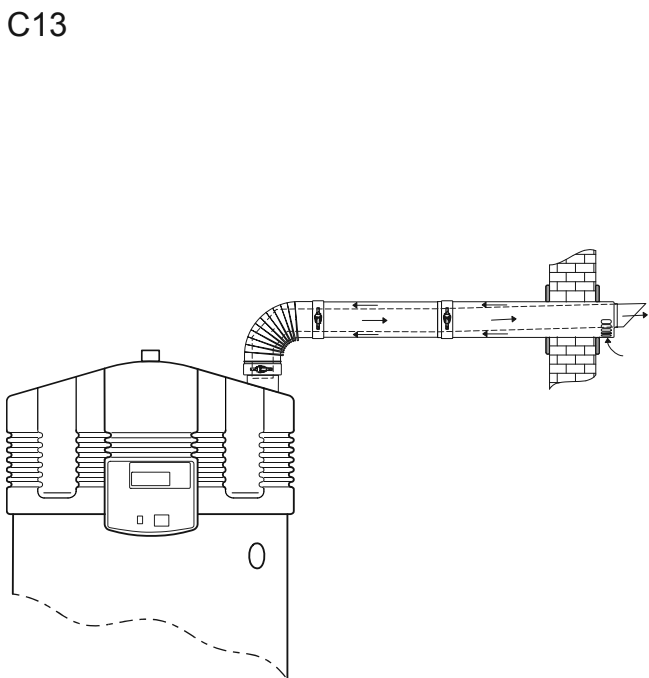

C53

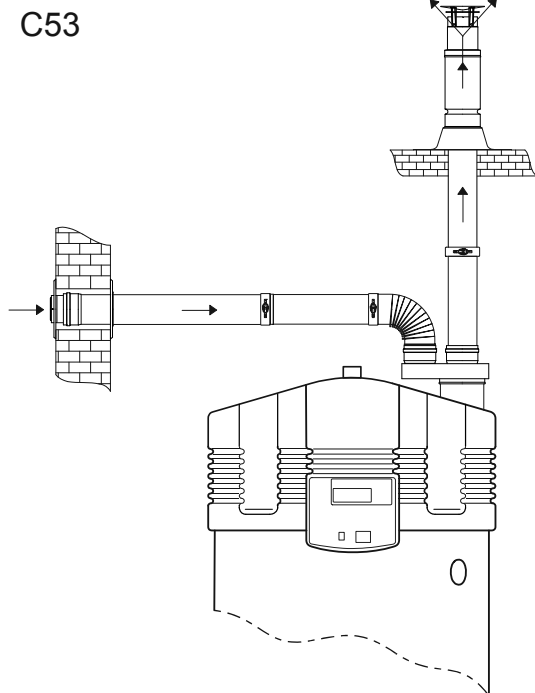

IMD-0789 R0

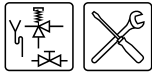

Explanation of types of installation

Installation type	Description
B23	Air for combustion is drawn from the boiler room.
C13	Concentric and/or parallel wall flue terminal.
C33	Concentric and / or parallel roof flue terminal
C43	Water heaters on common air supply and flue gas discharge (concentric and/or parallel) in multi-storey building.
C53	Air supply and flue gas discharge terminal types mixed.
C63	Water heaters supplied without flue gas discharge materials and/or terminal. These water heaters must be installed in compliance with local regulations.

Note

Make sure that the chimney flue discharges into an area approved for this type of installation.

3.10.3 Concentric connections

The table shows the requirements for concentric systems.

Warning

Install flue gas discharge pipe runs with a run-off of 5 mm per metre towards the water heater.

Flue gas discharge requirements for concentric systems (C13, C33)

Appliance	Diameter	Maximum length	Maximum number of 90° bends
SGE 40	100/150 mm	40 m	7
SGE 60	100/150 mm	40 m	7

Caution

Both conditions stated in the table must be fulfilled.

Even if you use less than the stated maximum number of bends, the maximum pipe length **still** may not be exceeded.

Even if you use less than the stated maximum pipe length, the maximum number of bends **still** may not be exceeded.

The following example illustrates how to use the table.

Practical example of concentric flue gas discharge

Example

The figure shows a SGE 60 installation. The water heater must be fitted with 10 m of concentric pipe (C13/C33) and four 90 degree bends. The configuration must be checked for compliance with the requirements stated in the table.

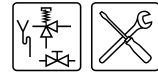

Water heater with concentric flue gas discharge material

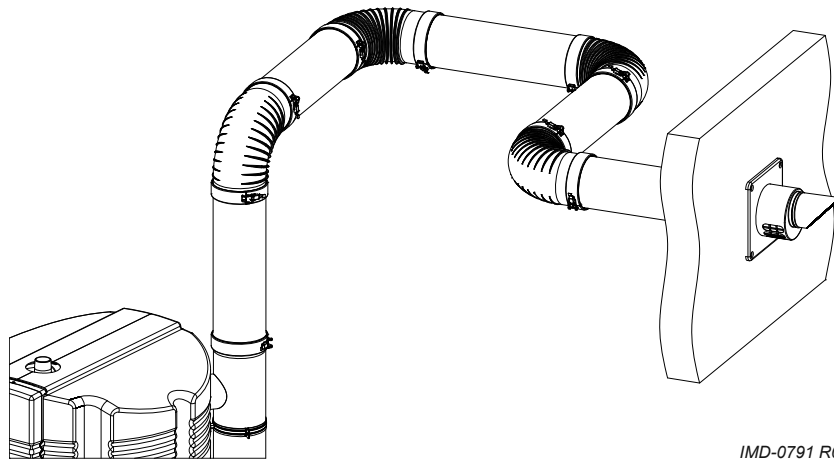

IMD-0791 R0

According to the table, the maximum permitted length is 40 metres, and 4 x 90 degree bends are permitted. Both requirements are fulfilled.

Specifications



Caution

For type C13 and C33 installations, A.O. Smith prescribes the use of a roof or wall flue terminal, exclusively of a type approved for the water heater. Use of an incorrect roof or wall-mounted flue terminal can cause the installation to malfunction.

Concentric wall flue terminal specifications C13

Subject	Description	
Wall flue terminal set: • 1x wall flue terminal (incl. wall flange & clamping ring) • 1x pipe 500 mm • 1x bend, 90°	Art. No.	0302 504 ¹
	Construction	Concentric
	Manufacturer	Muelink & Grol
	Model	M2000 MDV SEC
Pipe material	Construction	Concentric
	Flue gas discharge	Thick-walled aluminium with lip ring seal
	Air supply	Thin-walled galvanised sheet steel
Pipe diameters	Flue gas discharge	Ø 100 mm
	Air supply	Ø 150 mm
(1) No other wall flue terminal is permitted. Use this item number to order the wall conduit set from <i>supplier</i> , manufacturer or wholesaler.		

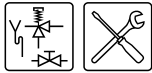

Concentric roof flue terminal specifications C33

Subject		Description
Roof flue terminal set: • 1x roof flue terminal (incl. clamping ring) • 1x pipe 1000 mm • 1x mounting flange	Art. No.	0304 423 ¹
	Construction	Concentric
	Manufacturer	Muelink & Grol
	Model	M2000 DDV HR-C
Pipe material	Construction	Concentric
	Flue gas discharge	Thick-walled aluminium with lip ring seal
	Air supply	Thin-walled galvanised sheet steel
Pipe diameters	Flue gas discharge	Ø 100 mm
	Air supply	Ø 150 mm
(1) No other roof flue terminal may be used. Use this item number to order the roof flue terminal set from the supplier, manufacturer or wholesaler.		

3.10.4 Parallel connections

The table states the maximum pipe lengths for parallel systems. The maximum pipe length depends on the chosen diameter.

Warning

Install flue gas discharge pipe runs with a run-off of 5 mm per metre towards the water heater.

Chimney flue requirements for parallel systems

Appliance	Diameter ¹	Maximum total length	L _{equivalent} 90° bend	L _{equivalent} 45° bend
SGE 40	100	55 m	4.6 m	1.2 m
SGE 60	100	55 m	4.6 m	1.2 m
SGE 40	130	100 m	2.4 m	1.4 m
SGE 60	130	100 m	2.4 m	1.4 m
1) Parallel systems with diameter of 100 mm. If the maximum total length when using a diameter of 130 mm is insufficient, a diameter of 150 mm must be used. Any diameter enlargement must be carried out on both air supply and flue gas outlet.				

You must use the longest pipe when calculating the pipe length. For example, if the chimney pipe is 4 metres and the air supply pipe is 3 metres, use 4 metres as the length for the calculation. Next, add the L_{equivalent} for every 90° and 45° bend to this 4 metres, in *both* the air supply and flue gas outlet. The following practical example illustrates how to use the table.

Practical example of parallel flue gas discharge

Example

The figure shows a SGE 60 installation. This has to be fitted with a 4 m parallel pipe 100 mm in diameter, plus four 90-degree bends. The configuration must be checked for compliance with the requirements stated in the table.

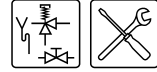

Appliance with parallel flue gas discharge material

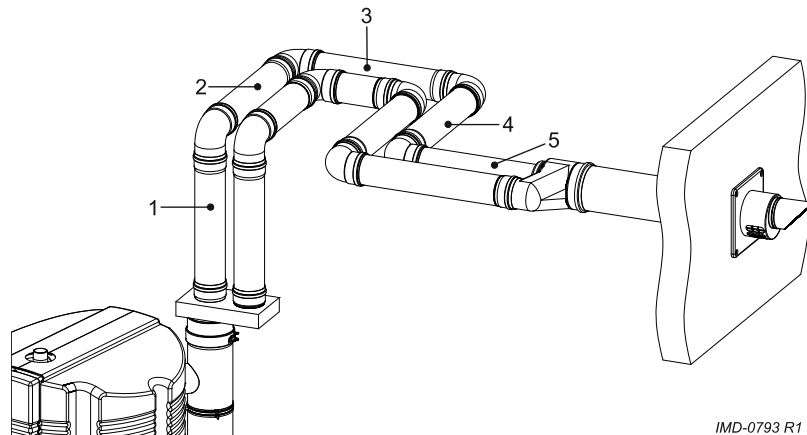

IMD-0793 R1

The longest pipe must be used to check the maximum length. In this case, the chimney pipe is the longest. This is 4 metres. This 4 metres is the sum of pipe sections 1 and 2. The length of the transition piece can be ignored. The total number of bends used in the chimney flue and air supply, is 4. The bend in the transition piece can be ignored. According to the table, 4.6 metres must be added for each bend. This brings the total pipe length to:

$$(4.6 \times 4) + 4 = 18.4 + 4 = 22.4 \text{ m.}$$

This is less than the maximum length of 55 metres stated in the table. The installation therefore meets the requirements.

3.11 Electrically connecting the water heater



Warning

The installation should be carried out by a competent person, in compliance with general and locally applicable regulations (1.3 "Regulations").

3.11.1 Introduction

This section covers the following topics:

- [Preparation](#)
- [Connecting the mains power](#)

Optionally, it is possible to connect an isolating transformer, a program-controlled pump (a pump between the storage tank and the water heater) and an extra alarm signal to the water heater. For these options, see:

- [Isolating transformer](#)
- [Connecting a program-controlled pump](#)
- [Connecting an extra ON mode switch](#)
- [Connect additional error signal](#)

Connecting the solar heating system is also described:

- [Connecting communication cable to solar heating system](#)



Note

The optional components are not included in the electrical power consumption rating stated in the table (3.4.2 "General and electrical specifications").

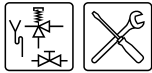

3.11.2 Preparation

Caution

The water heater is phase-sensitive. It is **absolutely essential** to connect the mains live (L) to the live of the water heater, and the mains neutral (N) to the neutral of the water heater.

Caution

There must be **no potential difference** between neutral (N) and earth (\perp). If this is the case, then an isolating transformer ([3.11.4 "Isolating transformer"](#)) must be used in the supply circuit.

For more information or to order this isolating transformer, please contact A.O.Smith Water Products Company.

The figure shows a view of the terminal block, and the table explains the relevant connections.

Connector block

Legend

- A. screws
- B. cover
- C. terminal block

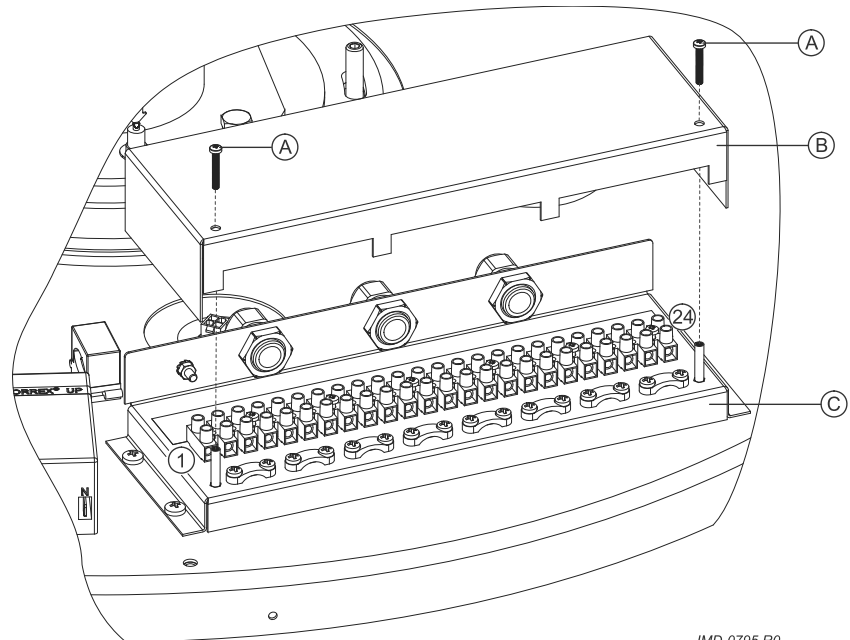

In preparation, you must first remove the two covers, and the cover of the electrical section.

1. Undo the screws of the covers.
2. Carefully remove the covers from the water heater.
The electrical section is now visible.
3. Loosen the 2 screws (A) and remove the cover (B) from the electrical section.
The connector block (C) is now visible.

Note

Consult the table for the connections and consult the electrical diagram for the electrical component connections.

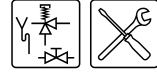

Terminal block

Mains voltage			Isolating transformer						Alarm Out			Program-controlled pump			16 to 20	External ON/OFF		Bus-link	
			primary			secondary										X ₃	X ₄	X ₅	X ₆
N	L	⏚	N	L ₁	⏚	N	L ₂	⏚	X ₁	X ₂	⏚	N	L ₃	⏚		X ₃	X ₄	X ₅	X ₆
1	2	3	4	5	6	7	8	9	10	11	12	13	14	15		21	22	23	24

3.11.3 Connecting the mains power

The water heater is supplied without a power cable and isolator.

Note

In order to receive electrical power, the water heater has to be connected to the mains power by means of a permanent electrical connection. A double-pole isolator with a contact gap of at least 3 mm must be fitted between this permanent connection and the water heater. The power cable must have cores of at least 3 x 1.0 mm².

Warning

Leave the water heater electrically isolated until you are ready to commission it.

1. Connect neutral (N), live (L) and earth (⏚) of the power cable to terminals 1 thru 3 of the terminal block as shown in the table (3.11.2 "Preparation").
2. Fit the power cable in the strain relief.
3. Connect the power cable to the isolator.
4. If you have no more connections to make:
 - Fit the cover on the terminal block.
 - Fit the covers onto the water heater.

3.11.4 Isolating transformer

An isolating transformer should be used if there is a case of 'floating neutral'.

Note

The total power consumed by the appliance goes via the isolating transformer.

1. Refer to the fitting instructions provided with the isolating transformer. (Contact the supplier for details of the correct isolating transformer.)
2. Connect the neutral (N), live (L) and earth (⏚) of the power cables to terminals 4 through 9 of the connection block according to the table (3.11.2 "Preparation").
3. Fit the cables in the strain relief.
4. If you have no more connections to make:
 - Fit the cover on the terminal block.
 - Fit the covers onto the water heater.
5. Connect the power cable to the isolator.



3.11.5 Connecting a program-controlled pump

Note

The maximum power capacity for a pump regulated by the controller is 100W.

1. Connect neutral (N), live (L) and earth (\perp) to terminals 13, 14 and 15 as indicated in the table (3.11.2 "Preparation").
2. Fit the cable in the strain relief.
3. If you have no more connections to make:
 - Fit the cover on the terminal block.
 - Fit the covers onto the water heater.

3.11.6 Connecting an extra ON mode switch

External ON/OFF is an option for connecting an external ON/OFF switch. In the OFF position, the programmed operating mode is active. In the ON position, the programmed operating mode is overruled, and "ON mode" is active.

1. Connect leads (X_3 and X_4) to terminals 21 and 22 according to the table (3.11.2 "Preparation").
2. Fit the cable in the strain relief.
3. If you have no more connections to make:
 - Fit the cover on the terminal block.
 - Fit the covers onto the water heater.

3.11.7 Connect additional error signal

The appliance has a terminal that is switched when an error is detected. This can be used to signal errors, for example with a bulb. A 230V circuit can be powered directly. Other voltages require a relay prescribed by the manufacturer.

1. Connect the phase cables (X_1 and X_2) to points 10 and 11 according to the table (3.11.2 "Preparation"). If required, connect earth (\perp) to terminal 12.
2. Fit the cable in the strain relief.
3. If you have no more connections to make:
 - Fit the cover on the terminal block.
 - Fit the covers onto the water heater.

3.11.8 Connecting communication cable to solar heating system

You must connect a communication cable between the controllers of the water heater and the solar heating system.

1. Connect the cables (X_5 and X_6) to terminals 23 and 24 as shown in the table (3.11.2 "Preparation").
2. Fit the cable in the strain relief.
3. If you have no more connections to make:
 - Fit the cover on the terminal block.
 - Fit the covers onto the water heater.

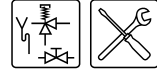

3.12 Electrical connection of the solar heating system

This section covers the following topics:

- [Preparation](#)
- [Connecting the mains power](#)
- [Connecting pump station - modulating pump](#)
- [Connecting solar collector](#)
- [Connecting tank sensor](#)
- [Connecting communication cable](#)

Optionally you can connect an extra head pump and Q/T sensor:

- [Connecting extra head pump](#)
- [Connecting Q/T sensor](#)

3.12.1 Preparation

See Eratta.

3.12.2 Connecting the mains power

Note

Just as with the water heater controller, the solar heating system controller must have a permanent electrical connection to the mains power supply. There must be a double-pole isolator installed in the permanent connection. This is the same double-pole isolator as installed between the mains power supply and the water heater itself. Whenever this isolator is operated, both controllers can be switched on or off.

1. Connect earth, live and neutral to terminals 1 through 3
2. Fit the cables in the strain relief.
3. Connect the power cable to the isolator.
4. Continue ([3.12.3 "Connecting pump station - modulating pump"](#)).

3.12.3 Connecting pump station - modulating pump

The pump station contains a modulating pump (4-wire connection). You must connect this pump to the controller of the solar heating system.

1. Connect earth, live and neutral to terminals 10 through 12 .
2. Connect the fourth lead to terminal 13.
3. Fit the cables in the strain relief.
4. Continue ([3.12.4 "Connecting solar collector"](#)).

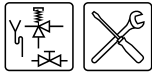

3.12.4 Connecting solar collector

Note

This sensor must be mounted in the solar collector; refer to the solar collector installation manual.

Connect the sensor (S_1) to the water heater as follows:

1. Connect the sensor to terminal 2 and 4 of J13.
2. Fit the cables in the strain relief.
3. Continue ([3.12.5 "Connecting tank sensor"](#)).

3.12.5 Connecting tank sensor

Note

This sensor is already mounted in the tank prior to delivery. The sensor is mounted between the inlet and outlet of the heat exchanger. However, you must still connect the lead to the solar heating system controller.

1. Connect the lead for sensor S_2 with the blade connectors to the sensor.
2. Connect the other end to terminals 2 and 4 of J14.
3. Fit the cables in the strain relief.
4. Continue ([3.12.6 "Connecting communication cable"](#)).

3.12.6 Connecting communication cable

Note

>The communication cable must always be connected, otherwise neither the appliance nor the solar heating system controller will run.

1. Connect the double connector to J16.
2. Fit the cable in the strain relief.
3. Connect the other end of the communication cable to the terminal block of the appliance. See
 - connecting communication cable to the appliance ([3.12.6 "Connecting communication cable"](#)).
 - electrical diagram for the appliance ([17.3 "Electrical diagram for the appliance"](#))
 - electrical diagram for the solar heating system ([17.4 "Electrical diagram, solar heating system"](#))
4. Connect the optional head pump ([3.12.7 "Connecting extra head pump"](#)) or Q/T sensor ([3.12.8 "Connecting Q/T sensor"](#)).
5. If you do not need to make any more connections:
 - Fit the cover over the controller.



3.12.7 Connecting extra head pump



Note

This pump is essential if a greater head is required. When the system has such a high resistance (>66 kPa) that the pump in the pump station is insufficient, you can connect a second (ON/OFF) pump to the solar heating system controller.

1. Connect earth (\perp), live and neutral to terminals 7 through 9.
2. Fit the cable in the strain relief.
3. If you need to connect an extra head pump, continue [\(3.12.8 "Connecting Q/T sensor"\)](#); otherwise:
 - Fit the covers over the controller.

3.12.8 Connecting Q/T sensor



Note

You can optionally add a Q/T sensor to the installation. This enables you to calculate the energy contribution of the system. For more information or to order the Q/T sensor, please contact your supplier.

1. Connect the 5V to J12-1.
2. Connect sensor S₄ to J12-2.
3. Connect earth to J12-3.
4. Connect the "flow signal" to J12-4.
5. Fit the cable in the strain relief.
6. If you have no more connections to make:
 - Fit the covers over the controller.

3.13 Check the supply pressure, gas control valve pressure, CO₂ value and switching pressure



Note

Before starting to use the appliance and/or checking the supply pressure and/or the CO₂ value and/or the switching pressure, you should first fill [\(5 "Filling"\)](#) the appliance.



Caution

When starting up for the first time or after conversion, you must always check the supply pressure, the gas control valve pressure, the CO₂ value and the switching pressure.



Note

A CO₂ meter and a pressure gauge must be available for checking the supply pressure, gas control valve pressure, CO₂ value and switching pressure.

3.13.1 Procedure for checking the supply pressure

To check the supply pressure, proceed as follows:

1. Isolate [\(10.3 "Isolating the water heater from the mains"\)](#) the appliance from the power supply.
2. Carefully remove the covers from the appliance.
3. The electrical section is now visible.
4. There is a test nipple before the gas control valve (for natural gas appliances) or before the pressure-reducing valve (for LPG appliances) so that the supply pressure can be measured.

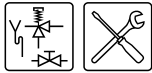

This test nipple has a sealing screw. Loosen the sealing screw by a few turns. Do not completely loosen it as it can be difficult to retighten.

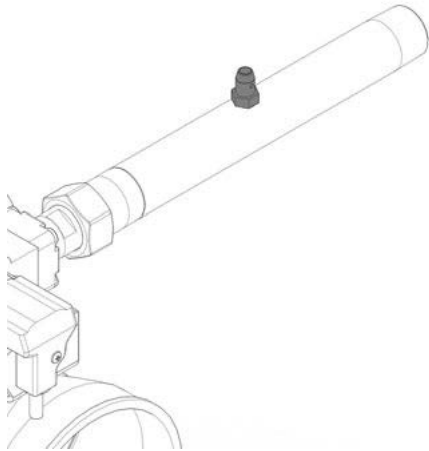

IMD-1095a R0

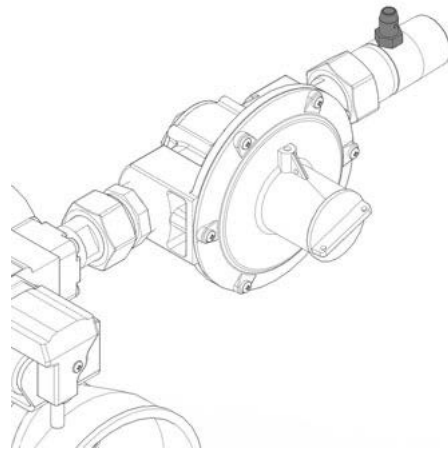

IMD-1096a R0

5. Open the gas supply and vent the gas supply line via the test nipple.
6. Connect a pressure gauge to the test nipple as soon as gas starts to flow from it.
7. Switch on the power to the appliance using the isolator on the appliance.
8. Switch the controller **ON** by setting the 0/I switch to **position I**.

The display will now show **INTERNAL CHECK** for about 10 seconds, and will then go to the main menu.

```
INTERNAL CHECK
```

```
SERVICE MENU  
SERVICE INTERVAL  
→SERVICE OPERATION  
▼ ANTI LEGIONELLA
```

9. Select **SERVICE OPERATION, FULL LOAD** from the service menu.
10. Confirm with **ENTER**.

The display shown here will appear.

```
SERVICE OPERATION  
→FULL LOAD  
PARTIAL LOAD
```

The appliance is now in "Full load mode" and will ignite.

11. You must wait about 1 minute after the display shows the text **RUNNING** before reading the dynamic pressures (the fan needs this time to get up to full speed, so that you can get a reliable reading).

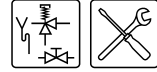

12. Use the pressure gauge to read the supply pressure and compare it against the value from the gas table (3.4.3 "Gas data").

Note

Consult the mains gas supply company if the supply pressure is not correct. You cannot yet start using the appliance. You must now take the appliance out of service (10.3 "Isolating the water heater from the mains").

Note

After conversion, you must check that the gas control valve is gastight.

13. Shut off the gas supply.
14. Disconnect the pressure gauge and retighten the sealing screw in the test nipple.
15. If there is nothing else you need to check or adjust, you can put the covers back on the appliance.

3.13.2 Procedure for checking the gas control valve pressure

The procedure for checking the gas control valve pressure is only applicable to appliances that have a pressure-reducing valve. If the appliance does not have a reducing valve, continue from adjusting the CO₂ value (3.13.3 "CO₂ adjustment").

To check the gas control valve pressure, proceed as follows:

1. Isolate (10.3 "Isolating the water heater from the mains") the appliance from the power supply.
2. Carefully remove the covers from the appliance.
3. The electrical section is now visible.
4. The gas control valve has a test nipple that can be used for measuring the gas control valve pressure. This test nipple has a sealing screw. Loosen the sealing screw by a few turns. Do not completely loosen it as it can be difficult to retighten.
5. Open the gas supply.
6. Connect a pressure gauge to the test nipple.
7. Switch on the power to the appliance using the isolator on the appliance.
8. Switch the controller ON by setting the 0/I switch to position I .

The display will now show INTERNAL CHECK for about 10 seconds, and will then go to the main menu.

```
INTERNAL CHECK
```

```
SERVICE MENU
  SERVICE INTERVAL
  →SERVICE OPERATION
  ▾ ANTI LEGIONELLA
```

9. Select SERVICE OPERATION, FULL LOAD from the service menu.

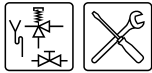

10. Confirm with **ENTER**.

The display shown here will appear.

```
SERVICE OPERATION
FULL LOAD
→PARTIAL LOAD
```

The appliance is now in "PARTIAL LOAD" mode and will ignite.

11. You must wait about 1 minute after the display shows the text **RUNNING** before reading the dynamic pressures (the fan needs this time to get up to full speed, so that a reliable reading can be obtained).
12. Use the pressure gauge to read the pressure and compare it against the value from the gas table (3.4.3 "Gas data").
13. If necessary, adjust the gas control valve pressure using the reducing valve's adjuster screw (2) until the value is within the range listed in the table

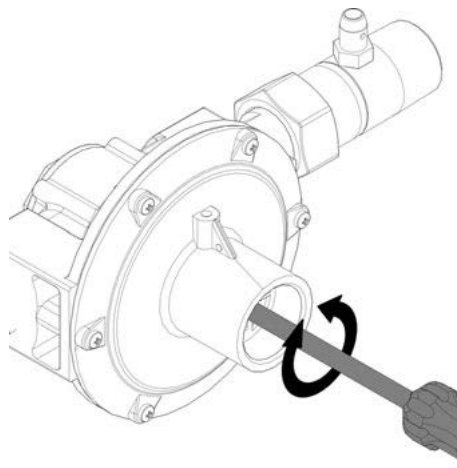

Gas control valve pressure adjustment



IMD-1096b R0

3.13.3 CO₂ adjustment

To check the CO₂ value under full load and partial load and to adjust it if necessary, proceed as follows:

1. Isolate (10.3 "Isolating the water heater from the mains") the appliance from the power supply.
2. Carefully remove the covers from the appliance.
3. The electrical section is now visible.
4. Place the CO₂ meter's measurement probe in the test nipple (58) of the flue gas outlet pipe.
5. Open the gas supply and vent the gas supply line.
6. Use the main switch to apply mains voltage to the appliance.
7. Start (9 "Starting the water heater") the appliance.
8. Go to the :SERVICE OPERATION menu.
9. Generate a heat demand by draining the appliance until it is cold or by raising the value for T_{set} in the SERVICE menu. Use  for this.

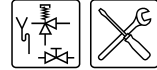

Full-load measurement

10. From the service menu, select:

- SERVICE OPERATION | FULL LOAD
- Confirm with ENTER.

The appliance is now in "FULL LOAD mode" and will ignite.

```
SERVICE  ▣      ▣
FULL LOAD      65°C
              Tset 70°C
RUNNING
```

11. The appliance is now running at FULL LOAD. Read the value from the CO₂ meter and wait until this measured value has remained stable for some time. This may take several minutes.

12. Then compare the measured CO₂ value against the value from the table (3.4.3 "Gas data").

Caution

The CO₂ value at full load must be within ± 1.0 vol% of the CO₂ value stated in the table (3.4.3 "Gas data").

13. If necessary, adjust the CO₂ value using the adjuster screw until the value is within the range listed in the table of CO₂ values.

Use the Allen key supplied for this. The key can be found in the plastic bag that is attached to the appliance.

CO₂ adjustment (full load)

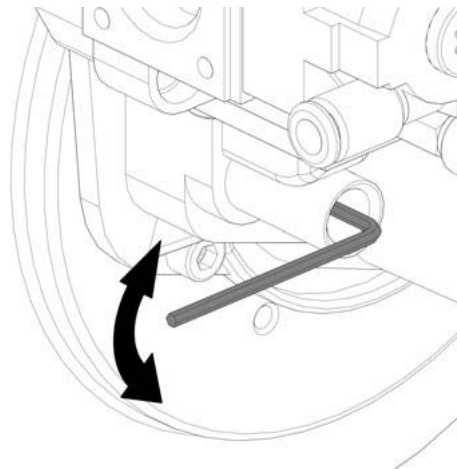

IMD-1095b R0

Note

Turning to the left (anticlockwise) means more gas (higher CO₂ level) and turning to the right (clockwise) means less gas (lower CO₂ level).

Note

After conversion, you must check that the gas control valve is gastight.

14. If you have increased T_{set}, set it back to the original value using ↓.

15. Continue with the CO₂ measurement under partial load.



Partial load measurement

16. From the service menu, select:

- SERVICE OPERATION | PARTIAL LOAD
- Confirm with **ENTER**.

The appliance is now in "PARTIAL LOAD" mode and will ignite.

```
SERVICE  ▾  ▾
PARTIAL LOAD  65°C
          Tset 70°C
RUNNING
```

17. The appliance is now running at **PARTIAL LOAD**. Read the value from the CO₂ meter and wait until this measured value has remained stable for some time. This may take several minutes.

18. Compare the CO₂ value measured against the value measured under full load.

Caution

The CO₂ value at partial load must be within ± 0.3 vol% of the CO₂ value measured or adjusted under full load.

19. If necessary, adjust the CO₂ value using the adjuster screw until the value is within 0.3 vol% of the CO₂ value under full load. Then compare the measured CO₂ value against the value from the table ([3.4.3 "Gas data"](#)).

CO₂ adjustment (partial load)

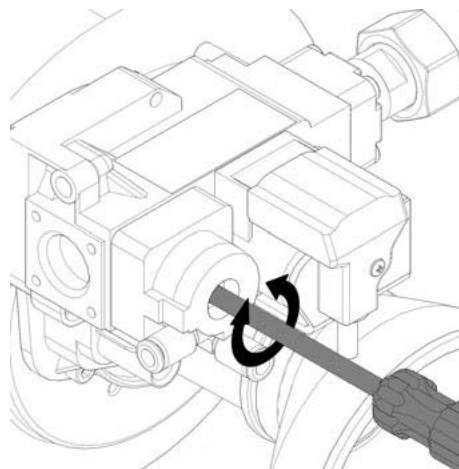

IMD-1095c R0

Note

Turning to the left (anticlockwise) means more less (lower CO₂ level) and turning to the right (clockwise) means more gas (higher CO₂ level).

Note

After conversion, you must check that the gas control valve is gastight.

20. Remove the CO₂ measurement probe from the measurement nipple of the flue gas outlet pipe.

21. Put the cap back on the measurement nipple of the flue gas outlet pipe.

22. Shut off the gas supply.

23. Replace the covers.

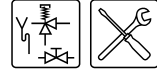

3.13.4 Switching pressure measurement

To measure the switching pressure, proceed as follows:

1. Isolate ([10.3 "Isolating the water heater from the mains"](#)) the appliance from the power supply.
2. Carefully remove the covers from the appliance.
3. The electrical section is now visible.
4. Remove the black caps from the measurement point of the pressure switch.
5. Connect the + of the pressure gauge to the H of the measurement point of the pressure switch.
6. Connect the - of the pressure gauge to the L of the measurement point of the pressure switch.
7. Zero the pressure gauge.
8. Start ([9 "Starting the water heater"](#)) the appliance.
9. The appliance will now run the heating cycle ([9.3 "The appliance's heating cycle"](#)).
10. Read the pressure from the meter at the moment when the appliance switches from PRE PURGE to PRESSURE SWITCH. At this point, the appliance's display will show:

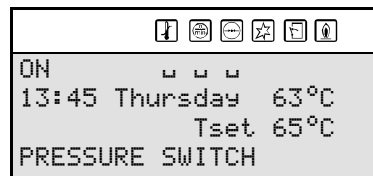

11. Check whether the measured value matches the value from the table ([3.4.3 "Gas data"](#)).

Note

If the message PRESSURE SWITCH does not appear, there is a fault. This must be resolved first by a qualified service engineer.

12. Shut off the gas supply.
13. Disconnect the pressure gauge.
14. Put the two black caps back on the pressure switch.
15. Replace the covers.



4 Conversion to a different gas category

4.1 Introduction



Caution

The conversion may only be carried out by a competent person.

If the appliance has to operate on a different family of gases (liquid petroleum gas or natural gas) or gas category other than that for which the appliance has been configured at the factory, then the appliance will have to be adapted using a special conversion kit. You can order the conversion kit you need from the supplier of your appliance. The conversion kit contains all the parts needed to do the conversion. A description of how to do the conversion is also delivered with the kit.

The following conversions are possible:

1. Conversion from natural gas to LPG.
2. Conversion from LPG to natural gas.
3. Conversion from natural gas to natural gas or LPG to LPG, if applicable.



Caution

After the conversion, you must check that the appliance is gastight and check the supply pressure, gas control valve pressure, the CO₂ value and the switching pressure.

4

Conversion to a different gas category

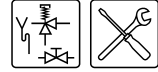

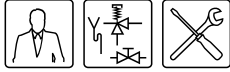

5 Filling

Installation diagram

Legend Vented and unvented
Unused numbers are not applicable

1. pressure reducing valve (mandatory)
3. T&P valve (mandatory)
4. stop valve (recommended in pipe C and mandatory in pipe A)
5. non-return valve (mandatory)
6. circulation pump (optional)
9. drain valve (mandatory)
10. manual gas valve (mandatory)
20. pressure valve (mandatory)
26. air bleed (mandatory)
11. service stop valve (recommended)
12. temperature gauge (recommended)
13. condensation drain (mandatory)
14. draw-off points
15. expansion valve (mandatory)
16. expansion vessel (mandatory)
17. 3-way aeration valve (recommended)
18. cold water head tank
19. float switch
23. pressure valve (mandatory)
37. combined Q/T sensor (optional)
38. solar heating system pump station (modulating - mandatory)
- A. cold water supply
- B. hot water supply
- C. circulation pipe
- D. gas supply
- E. overflow pipe
- F. supply heat exchanger
- G. heat exchanger return
- H. overflow protection
- S₁. collector sensor (mandatory)
- S₂. tank sensor (mandatory)
- S₄. heat exchanger discharge sensor (optional)

UNVENTED

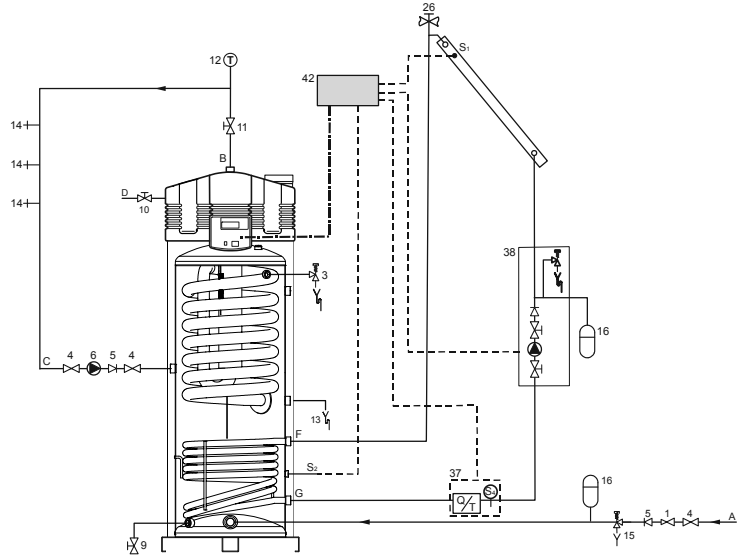

VENTED

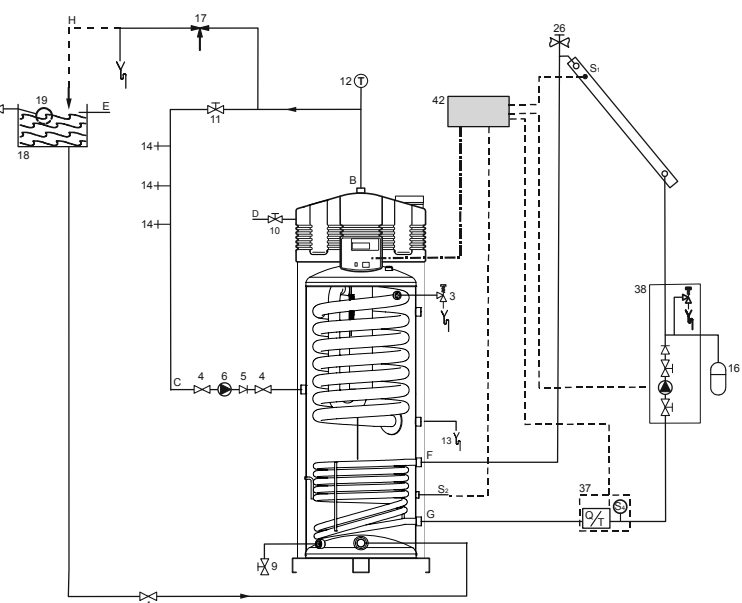

IMD-0783 R0

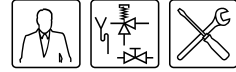

⚠ Caution

The installation diagram shows a pump station with an integrated non-return valve. This type of pump unit may only be used with closed systems. In systems with drain-back, installation of a pump unit with non-return valve is prohibited. There are special pump units for these systems. Please contact the pump unit supplier for this.

5.1 Filling unvented installations
⚠ Caution

The installation diagram shows a pump station with an integrated non-return valve. This type of pump unit may only be used with closed systems. In systems with drain-back, installation of a pump unit with non-return valve is prohibited. There are special pump units for these systems. Please contact the pump unit supplier for this.

To fill the water heater, proceed as follows:

1. Open the stop valve (11) in the hot water pipe and, if present, the stop valves (4) for the circulation pump (6).
2. Close the drain valve (9).
3. Open the nearest hot water draw-off point (14).
4. Open the valve of the inlet combination (2) so that cold water flows into the water heater.
5. Completely fill the water heater. When a full water jet flows from the nearest draw-off point, the water heater is full.
6. Bleed the entire installation of air, for example by opening all draw-off points.
7. The water heater is now under water supply pressure. There should now be no water coming out of the inlet combination expansion valve or out of the T&P valve (3). If there is, the cause might be:
 - The water supply pressure is greater than the specified 8 bar. Rectify this by fitting a pressure reducing valve (1).
 - The expansion valve in the protected cold supply set-up is defective or incorrectly fitted.
 - The T&P valve is defective, or incorrectly installed.

5.2 Filling vented installations

To fill the water heater, proceed as follows:

1. Open the stop valve (11) in the hot water pipe and, if present, the stop valves (4) for the circulation pump (6).
2. Close the drain valve (9).
3. Open the nearest hot water draw-off point (14).
4. Open the stop valve (4) on the cold water side (A) so that cold water flows into the water heater.
5. Completely fill the water heater. When a full water jet flows from the nearest draw-off point, the water heater is full.
6. Bleed the entire installation of air, for example by opening all draw-off points.
7. The water heater is now under water supply pressure. There should be no water coming out of the T&P valve (3). If this does happen, the T&P valve might be defective or incorrectly fitted.

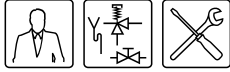

5.3 Filling solar heating system

Note

No special safety measures are required when working with the diluted glycol solution specified by the manufacturer. For more information about the fluid, please contact the manufacturer.

Warning

Before filling the solar heating system to replenish the heating fluid, make certain that:

- The appliance is switched off ([10.2 "Decommissioning the water heater for a short period"](#)).
 - The solar heating system is switched off. Refer to the documentation of the solar heating system.
 - The appliance has cooled down sufficiently to prevent personal injury (burns).
-

Note

The filling procedure described in this manual is intended for the pump system supplied by the supplier of the appliance. For any other system, you should follow the procedure for that system.

Warning

To avoid contaminating the glycol, you should flush the solar heating system through with water before filling.

5.3.1 Flushing with water

1. Connect a water supply to the filling point of the pump station.
2. Connect a drain hose to the drain point.
3. Open the taps of both supply and drain point.
4. Open the water supply tap.
5. Allow the system to spool through until no further contamination comes out of the drain hose.
6. Then shut off the water supply.
7. Drain all remaining water from the system.
8. Now you can fill the system with glycol.

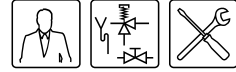

5.3.2 Filling met glycol

1. Insert the hose of the glycol pump into the jerry can containing the glycol.
2. Connect the pump to the jerry can.
3. Connect the hose of the glycol pump to the inlet combination of the pump station.
4. Open the valve of the inlet combination.
5. Plug the glycol pump into a mains socket.
6. Start the glycol pump using the ON/OFF switch on the glycol pump.
7. Stop the glycol pump as soon as the pressure gauge on the pump station begins to rise.
8. Completely bleed the system of air at the air bleed point (26, see installation diagram).
9. Close the air bleed when no further air comes out.
10. Use the service menu ([12.10.2 "Switching on the solar pump"](#)) to switch the pump on.

Note

To ensure that the solar heating system is properly filled, the pump in the solar heating system can be switched on for 2 minutes using the service menu.

-
11. Repeat steps 6 through 9 until glycol runs out of the air bleed (26).

Note

If an installation does not have a drain-back system, then it should be filled up to pressure (1.5 bar).
If an installation does have a drain-back system, then it should not be pressurised. For the installation, filling and drainage of a drain-back system, please refer to the installation manual and users manual of the solar collectors.

-
12. Switch off the glycol pump.
 13. Close the valve of the inlet combination and disconnect the glycol pump (including the hoses).

Note

Dispose of the residual glycol in the filler hose in an environment-friendly manner, and according to local regulations.

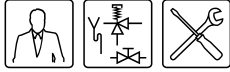

6 Draining

Installation diagram

Legend Vented and unvented
Unused numbers are not applicable

- 1. pressure reducing valve (mandatory)
- 3. T&P valve (mandatory)
- 4. stop valve (recommended in pipe C and mandatory in pipe A)
- 5. non-return valve (mandatory)
- 6. circulation pump (optional)
- 9. drain valve (mandatory)
- 10. manual gas valve (mandatory)
- 20. pressure valve (mandatory)
- 26. air bleed (mandatory)
- 11. service stop valve (recommended)
- 12. temperature gauge (recommended)
- 13. condensation drain (mandatory)
- 14. draw-off points
- 15. expansion valve (mandatory)
- 16. expansion vessel (mandatory)
- 17. 3-way aeration valve (recommended)
- 18. cold water head tank
- 19. float switch
- 23. pressure valve (mandatory)
- 37. combined Q/T sensor (optional)
- 38. solar heating system pump station (modulating - mandatory)
- A. cold water supply
- B. hot water supply
- C. circulation pipe
- D. gas supply
- E. overflow pipe
- F. supply heat exchanger
- G. heat exchanger return
- H. overflow protection
- S₁. collector sensor (mandatory)
- S₂. tank sensor (mandatory)
- S₄. heat exchanger discharge sensor (optional)

UNVENTED

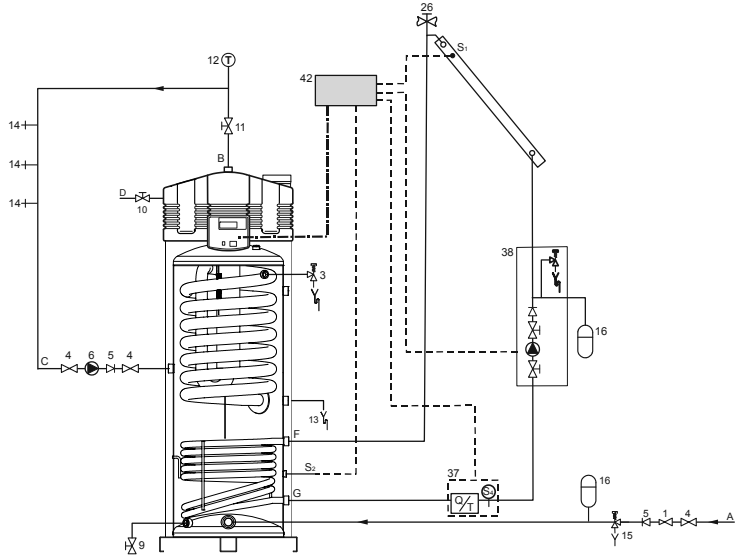

VENTED

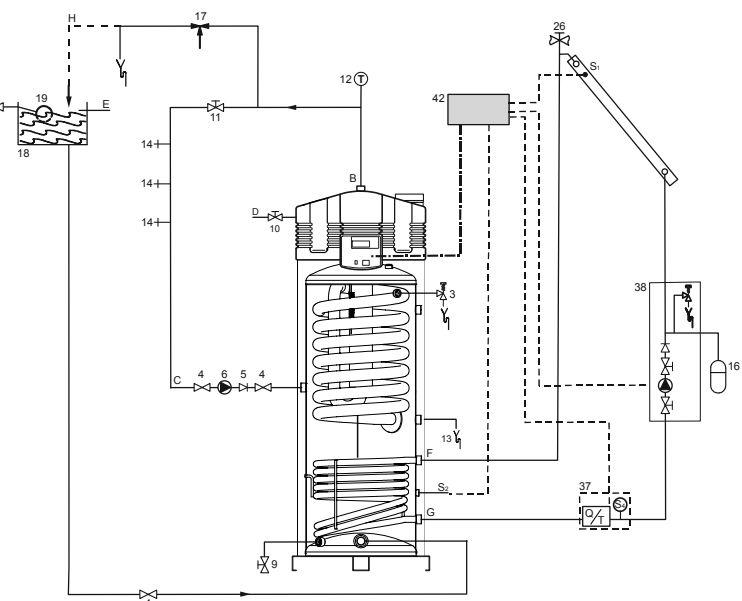

IMD-0783 R0

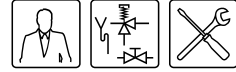

Caution

The installation diagram shows a pump station with an integrated non-return valve. This type of pump unit may only be used with closed systems. In systems with drain-back, installation of a pump unit with non-return valve is prohibited. There are special pump units for these systems. Please contact the pump unit supplier for this.

6.1 Draining unvented installations

Some service activities require the water heater to be drained. The procedure is as follows:

1. Activate the MENU with .

```
MENU
→OFF
▲ ON
▼ WEEK PROGRAM
```

2. Position the cursor in front of OFF.
3. Confirm OFF with ENTER.
4. Wait until the fan has stopped. The  icon is then dimmed.



Caution

Failure to wait until the fan stops can cause damage to the water heater.

5. Switch the water heater OFF (position 0) using the ON/OFF switch on the control panel.
6. Isolate the water heater from the power supply by setting the isolator between the water heater and the mains power supply to position 0.
7. Shut off the gas supply (10).
8. Close the stop valve (11) in the hot water pipe.
9. Close the supply valve (4) in the cold water inlet (A).
10. Open the drain valve (9).

6.2 Draining vented installations

Some service activities require the water heater to be drained. The procedure is as follows:

1. Activate the MENU with .
2. Position the cursor in front of OFF.
3. Confirm OFF with ENTER.
4. Wait until the fan has stopped. The  icon is then dimmed.

Caution

Failure to wait until the fan stops can cause damage to the water heater.

5. Switch the water heater OFF (position 0) using the ON/OFF switch on the control panel.
6. Isolate the water heater from the power supply by setting the isolator between the water heater and the mains power supply to position 0.
7. Shut off the gas supply (10).
8. Close the stop valve (11) in the hot water pipe.
9. Close the stop valve (4) between the cold water head tank and the cold water inlet (A).
10. Open the drain valve (9).
11. Bleed the water heater (or installation) so that it drains completely.

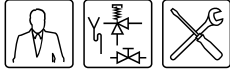

6.3 Draining solar heating system

Note

No special safety measures are required when working with the diluted glycol solution specified by the manufacturer. For more information about the fluid, please contact the manufacturer.

1. Activate the MENU with .

```
MENU
→OFF
▲ ON
▼ WEEK PROGRAM
```

2. Position the cursor in front of OFF.
 3. Confirm OFF with ENTER.
 4. Wait until the fan has stopped. The  icon is then dimmed.
-

Caution

Failure to wait until the fan stops can cause damage to the water heater.

Warning

The fluid in the pipes and the pipes themselves can be extremely hot! You should therefore wait until the water heater has cooled down sufficiently.

5. Switch off the solar heating system.
 6. Connect a hose to the lowest drain point in the solar heating system.
 7. Insert the hose into the glycol jerry can.
 8. Open the valve of the lowest drain point.
 9. Open the air bleed point (26) of the solar heating system.
 10. Close the drain point when the jerry can is full.
 11. Insert the hose in a new jerry can.
 12. Repeat steps 6 and 7 until no further glycol comes out of the system.
 13. Close the air bleed point and the valve of the drain point.
 14. Remove the hose.
-

Note

Dispose of the drained glycol in an environment-friendly manner, and according to local regulations.

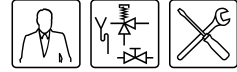

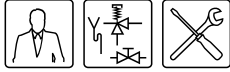

7 The control panel

7.1 Introduction

This chapter covers the following topics:



- Control;
- Explanation of icons;
- ON/OFF switch on controller;
- Navigation buttons;
- PC connection.

7.2 Control

The control panel is completely menu-driven, and comprises:

- a 4-line display with 20 characters per line;
- 6 buttons for controlling the water heater (below the display);
- 6 graphical symbols (above the display);
- a connector for a service PC;
- an ON/OFF switch.

The buttons are divided into three groups:

- Navigation buttons:
 - Buttons for UP ↑, and DOWN ↓;
 - Enter: ENTER;
 - Reset button: RESET
- The main menu (11 "Main menu"): ;
- the service program (12 "Service program"): . This chapter is specifically intended for the service and maintenance engineer and installation engineer.



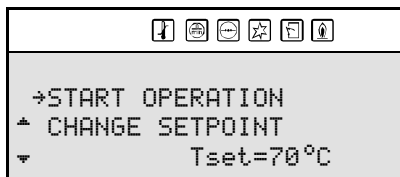



In this manual, the display of the controller is shown as in the figure, both with and without icons.



7.3 Explanation of icons

The table explains the meanings of the icons.

Icons and their meaning

	Name	Explanation
	Heat demand	Heat demand detected
	Purge	Pre- and post-purge using fan
	Pressure switch	Pressure switch is closed
	Glow	(Pre)glow
	Gas control valve	Gas control valve open/ignition
	Flame detection	Water heater operational
	Solar heating system	Solar energy is heating the water

7.4 ON/OFF switch on controller

The ON/OFF switch of the controller turns the water heater ON and OFF. Note that in the OFF position the water heater remains electrically live, in order for the continuous pump to stay running.

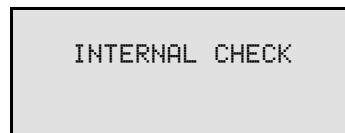

After switching on, the text INTERNAL CHECK appears on the display for about 10 seconds. The main menu (11 "Main menu") then appears. If no selection is made in the main menu, the water heater automatically switches to the OFF mode (8.2 "Operating modes").

Note

To electrically isolate the water heater, you must use the isolator between the water heater and the mains power supply.

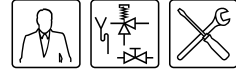

7.5 Navigation buttons

The use of these buttons is explained with the help of the figure showing the main menu (11 "Main menu").

The navigation buttons are:

- Buttons for UP ↑, and DOWN ↓;
- Enter: ENTER;
- Reset button: RESET.

The arrows ▲ and ▼ indicate that you can scroll up and/or down. Use the buttons ↑ and ↓ to scroll.

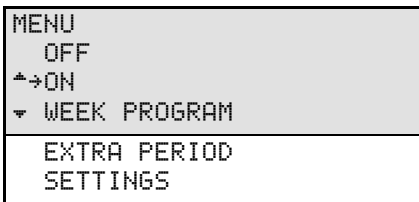

The cursor → points to the option to be activated. In the display as shown in the figure, you can scroll through the main menu.

The main menu comprises: OFF, ON, WEEK PROGRAM, EXTRA PERIOD and SETTINGS. You have to scroll down further to see the options EXTRA PERIOD and SETTINGS.

The selected option is confirmed using ENTER.

Pressing the RESET button takes you back one page in a menu and discards all options selected in the current menu.

Note

The RESET button is also used to reset the water heater following an error.

7.6 PC connection

The PC connection is exclusively intended to enable technicians from A.O.Smith to read the status and history of the water heater. These details can be important for troubleshooting and/or resolving complaints.

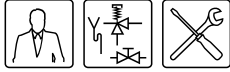

8 Status of the water heater

8.1 Introduction

This chapter covers the following topics:

- [Operating modes](#);
- [Error conditions](#);
- [Service condition](#);
- [Anode warning](#);
- [Q/T Sensor warning](#);
- [Collector temperature warning](#)

8.2 Operating modes

When running, the water heater has four basic operating modes, namely:

- [OFF](#)
- [ON](#)
- [EXTRA](#)
- [PROG](#)

8.2.1 OFF

In this mode, the frost protection is activated. The figure shows the display with the following information:

- line one: the text OFF;
- line two: the time, the day and T_1 . ([9.3 "The appliance's heating cycle"](#))
- lines three and four: the text FROST PROTECTION ACTIVATED.

```
OFF
13:45 Thursday 6°C
FROST PROTECTION
ACTIVATED
```

8.2.2 ON

In this mode, the water heater continually responds to the hot water demand. The figure shows the display with the following information:

- line one: the text ON;
- line two: the time, the day and T_1 . ([9.3 "The appliance's heating cycle"](#))
- line three: the programmed water temperature T_{set} ;
- line four: is empty when the water heater is idle, or depending on the operating cycle ([9.3 "The appliance's heating cycle"](#)), displays a text such as HEAT DEMAND.

```
ON
13:45 Thursday 67°C
Tset 75°C
```

8.2.3 EXTRA

In this mode, one extra period is programmed and activated. In this mode, the OFF or PROG mode is temporarily overruled to fulfil a single period of demand. When the period has passed, the water heater automatically returns to the previous operating mode. The figure shows the display with the following information:

- line one: the text EXTRA;
- line two: the time, the day and T_1 ; ([9.3 "The appliance's heating cycle"](#))
- line three: the switch-on time and the related water temperature setting;
- line four: the text PERIOD ACTIVATED.

```
EXTRA
12:30 Thursday 76°C
TH 12:45 Tset 75°C
PERIOD ACTIVATED
```

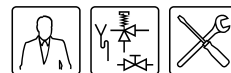

8.2.4 PROG

In this mode a preset week program is active, and the water heater responds continually to demand within the time periods set in the week program. There are two distinct situations possible in this mode:

```

PROG
10:00 Monday 76°C
MO 11:15 Tset 75°C
  
```

1. The current time falls within a set time period of the week program.

The figure shows the display with the following information:

- line one: the text PROG;
- line two: the time, the day and T_1 ; (9.3 "The appliance's heating cycle")
- line three: the next scheduled switch-off time and the water temperature T_{set} of the active period
- line four: is empty, or depending on the operating cycle (9.3 "The appliance's heating cycle"), displays a text such as HEAT DEMAND.

```

PROG
12:00 Monday 76°C
MO 11:15
PERIOD ACTIVATED
  
```

2. The current time falls outside a set time period of the week program.

The figure shows the display with the following information:

- line one: the text PROG;
- line two: the time, the day and T_1 ; (9.3 "The appliance's heating cycle")
- line three: the next scheduled switch-on time;
- line four: displays the text PERIOD ACTIVATED.

In all modes, the temperature may at any moment drop below the desired temperature. The water heater then enters an operating cycle. This operating cycle is identical (9.3 "The appliance's heating cycle") for all basic operating modes.

Note

Setting and if necessary programming of the basic operating modes are described in the main menu (11 "Main menu") chapter.

8.3 Error conditions

The figure shows an example of an error condition. If the water heater enters this condition, the display will show the following information:

- line one: error code comprising a letter and two digits, followed by the error description;
- lines two to four: alternately, a brief explanation of the error, and a brief action to resolve the error.

```

S04: SENSOR ERROR
CHECK
SENSOR OR DUMMY
  
```

Caution

The displayed action to resolve the error may only be performed by a service and maintenance engineer.

There are various types of errors:

- LOCK OUT ERRORS

When the cause has been removed, these errors require a reset with the **RESET** button before the water heater can resume operation.
- BLOCKING ERRORS

These errors disappear automatically once the cause of the error has been removed, after which the water heater resumes operation by itself.

The display does not show what type of error has been detected. A comprehensive overview of the errors is provided elsewhere in the manual (13 "Errors").

If, as end-user, you find the water heater in an error condition, you may attempt to re-start the water heater by pressing the **RESET** button once.

However, if the error returns or occurs several times in a short time, you must contact your service and maintenance engineer.

8.4 Service condition

The figure shows the message

```

!!! WARNING !!!
MAX. BURNING HOURS:
SERVICE REQUIRED
  
```

SERVICE REQUIRED. If this message appears, the water heater needs a service and maintenance inspection. In this case, contact your service and maintenance engineer.

Note

The message **SERVICE REQUIRED** is based on the number of expired burning hours and the preset service interval. If the service interval has been incorrectly selected, contact the service and maintenance engineer for instructions on how to rectify this. Information on the frequency of maintenance is provided elsewhere in the manual (14 "Service interval").

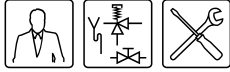

8.5 Anode warning

This message appears when the anode protection is no longer active. If the message appears, you must contact your service and maintenance engineer.

```
!!! WARNING !!!  
  
POWER ANODE  
MALFUNCTION
```

Note

The water heater continues to function when this message appears.

8.6 Q/T Sensor warning

This message appears if the Q/T sensor has not been connected (properly) but has been selected in the service programme ([12.10.5 "Setting the Q/T sensor"](#)). If the message appears, you must contact your service and maintenance engineer.

```
!!! WARNING !!!  
  
Q/T SENSOR NOT  
CORRECTLY CONNECTED
```

8.7 Collector temperature warning

This message appears whenever the collector temperature is too high. This message disappears automatically. If the message does not disappear, you must contact your service and maintenance engineer.

```
!!! WARNING !!!  
  
TEMPERATURE  
COLLECTOR  
TOO HIGH
```

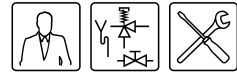

9 Starting the water heater

9.1 Introduction

This chapter covers the following topics:

- [Starting the appliance.](#)
- [The appliance's heating cycle.](#)

Note

The first time the water heater is started, you must enter (12.10 "Solar heating system configuration") the settings of the solar heating system.

9.2 Starting the appliance

Start the water heater as follows:

1. Fill the water heater (5 "Filling").
2. Open (3.5 "Installation diagram") the manual gas valve.
3. Switch on the power to the water heater using the isolator between the water heater and the power supply.
4. Switch the controller **ON** by setting the ON/OFF switch to **position I**.

The display will now show **INTERNAL CHECK** for about 10 seconds and will then go to the main menu.

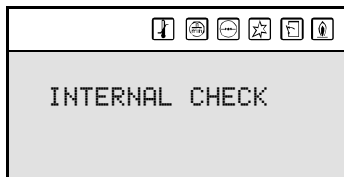

5. Press once on the blue arrow (v) to position the cursor beside **ON**, then press **ENTER**. The display shown in the figure will appear.

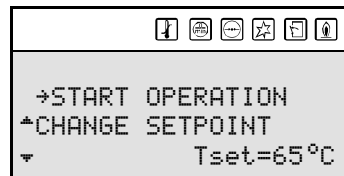

6. Confirm the selection **START OPERATION** with **ENTER**.

The appliance is now in "ON mode". If there is a heat demand, the appliance will run through the heating cycle (9.3 "The appliance's heating cycle").

If the heating cycle is not run, there is no heat demand; if this is the case, Tset will probably need to be set (11.4 "Setting the water temperature").

9.3 The appliance's heating cycle

The appliance's heating cycle is activated when the measured water temperature (T_1) falls below the threshold value (T_{set}). This threshold value depends on the currently selected appliance operating mode. For example, if the appliance is in "OFF" mode (frost protection), then this value is 5°C. If the appliance is in "ON mode", this threshold value is adjustable, for example to 65°C.

The heating cycle runs successively through the following states:

1. HEAT DEMAND;
2. PRE-PURGE;
3. PRESSURE SWITCH;
4. PRE-GLOW;
5. IGNITION;
6. RUNNING;
7. POST-PURGE.

The entire cycle is explained in the following example, which assumes the water heater is in operating mode **ON**.

Note

The same operating cycle applies to the other operating modes.

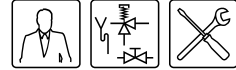

When the water heater starts, it will run through the following steps:

1. The water temperature drops below the set temperature of (for example) 65°C. The controller detects a heat demand and starts the operating cycle.
 - The icon is activated.
 - The message HEAT DEMAND appears.

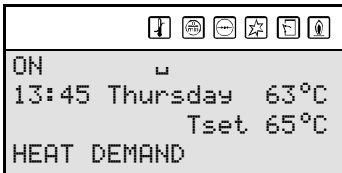

2. Once demand is registered, the fan is started to vent any gases that may be present. This phase is called pre-purge and lasts about 15 seconds.
 - The icon is activated.
 - The message PRE PURGE appears.

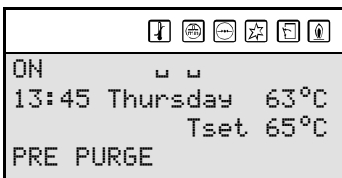

3. During the pre-purge, the pressure switch closes.
 - The icon is activated.
 - The message PRESSURE SWITCH appears.

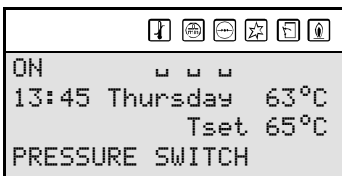

4. This is then followed by the (pre-)glow of the hot surface igniter.
 - The icons and are dimmed
 - The icon is activated.

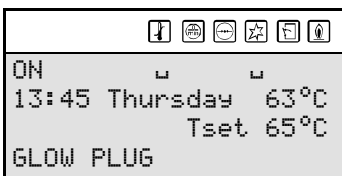

5. After a number of seconds pre-glow, the gas control valve is opened and ignition takes place.
 - The icon is activated.
 - The message IGNITION appears.

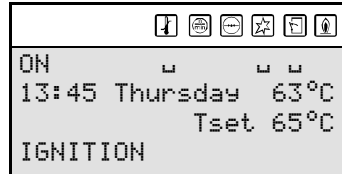

6. After ignition, the flame is detected and the appliance will be running. This means that actual heating has started:
 - The icon is dimmed.
 - The icon is activated.
 - The message RUNNING appears.

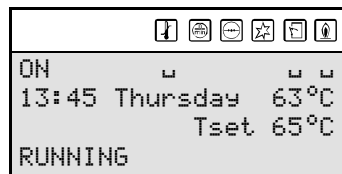

7. When the water is up to temperature, the heat demand ceases and the post-purge starts. This takes about 25 seconds.
 - The icons , and are dimmed.
 - The icon is activated.
 - The message POST PURGE appears.

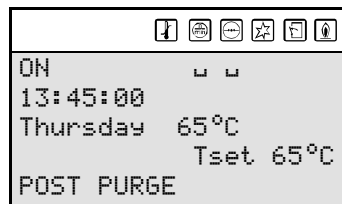

8. Following the post-purge, the fan stops and the pressure switch opens:
 - The icons and are dimmed.
 - The message POST PURGE vanishes.

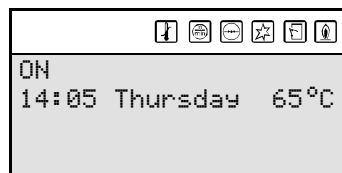

With any subsequent heat demand, the heating cycle will resume from step 1.

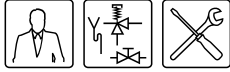

10 Shutting down

10.1 Introduction

This chapter describes:

- [Decommissioning the water heater for a short period.](#)
- [Isolating the water heater from the mains;](#)
- [Decommissioning the water heater for a long period.](#)

10.2 Decommissioning the water heater for a short period

To decommission the water heater for a short period, you must activate the frost protection.

The frost protection will prevent water from freezing in the water heater.

Activate the frost protection as follows:

1. Press button to select the main menu.
2. Using and , place the cursor beside OFF. Confirm with ENTER.

```
OFF
13:45 Thursday 6°C
FROST PROTECTION
ACTIVATED
```

The frost protection cuts in when the water temperature drops below 5°C. The text FROST will then appear on line one of the display. The water heater will heat the water to 20°C (T_{set}) before dropping back to mode OFF.

Note
These values of 5°C and 20°C cannot be adjusted.

Caution
The anode protection remains active when the OFF mode is selected.

Note
If the water heater is not used for longer than two months and the water is not drained, air bubbles may form in the water heater. This can lead to air in the water pipes.

10.3 Isolating the water heater from the mains

The water heater may only be isolated from mains power in the correct way. The correct procedure is as follows:

1. Activate the MENU with .
2. Position the cursor in front of OFF.
3. Confirm OFF with ENTER.

```
MENU
→OFF
▲ ON
▼ WEEK PROGRAM
```

Caution
Failure to wait until the fan stops can cause damage to the water heater.

4. Wait until the fan has stopped. The icon is then dimmed.
5. Switch the water heater **OFF (position 0)** using the ON/OFF switch on the control panel.
6. Isolate the water heater from the power supply by setting the isolator between the water heater and the mains power supply to position 0.

Note
Setting the main switch between the water heater and the electricity mains to 0 will switch off the power supply to the potentiostat; there is then no longer any anode protection.

10.4 Decommissioning the water heater for a long period

Drain the water heater if you are decommissioning it for a long period. Proceed as follows:

1. Isolate the water heater from the power supply ([10.3 "Isolating the water heater from the mains"](#)).
2. Shut off the gas supply.
3. Close the stop valve in the hot water pipe.
4. Close the supply valve of the protected cold supply set-up.
5. Open the drain valve
6. Bleed the water heater (or installation) so that it drains completely.

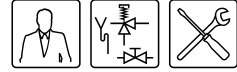



11 Main menu

11.1 Introduction

The MENU is reached by pressing the  button on the controller.

```
MENU
→OFF
▲ ON
▼ WEEK PROGRAM
-----
EXTRA PERIOD
SETTINGS
```

The main menu comprises:

- OFF
Select this option if you wish to shut the water heater down (10 "Shutting down") for a brief period, but do not wish to drain it. In this mode, the frost protection is active. This prevents water from freezing in the water heater.
- ON
In this mode, the water heater continually responds to the hot water demand (11.3 "Switching to "ON mode").
- WEEK PROGRAM
Select this option to allow the water heater to respond to demand only during pre-programmed periods (11.5 "Week program"). Outside those periods, only frost protection is active.
- EXTRA PERIOD
Select this option to overrule OFF mode or PROG mode (i.e. Week program) so that a single temporary period (11.10 "Extra period") of heat demand will be fulfilled.
- SETTINGS
Select this option to set (11.11 "Settings") the language and the time. You can also use this option to display the regulation interval (temperature), and the ignition and working speeds of the fan.

Note







If you fail to make any selection with the main menu open, then after 30 seconds, the water heater will automatically return to the mode it was previously in.

11.2 Notation convention for menu-related instructions

The MENU () of the controller is divided into sub-menus. For example, SETTINGS is one of the functions reached from the main menu. The menu SETTINGS is itself divided into sub-menus. For example, LANGUAGE is a sub-menu of SETTINGS. So, for example, to select menu LANGUAGE, this manual employs the following convention:

-  : SETTINGS | LANGUAGE
Confirm with ENTER.

This means:

1. : Activate the main menu with .
2. SETTINGS: Using button  and/or  go to SETTINGS and confirm with ENTER.
3. LANGUAGE: Using button  and/or  go to LANGUAGE
4. Confirm with ENTER. After pressing ENTER, you will have activated sub-menu LANGUAGE.

11.3 Switching to "ON mode"

You can switch the water heater to ON mode from any operational mode, as follows:

1. : ON | START OPERATION
Confirm with ENTER.

Note

Also refer to the chapter on starting the water heater (9 "Starting the water heater").

11.4 Setting the water temperature

11.4.1 Setting the water temperature via the SET POINT MENU

Set the water temperature via:

1. : ON | CHANGE SETPOINT
Confirm with ENTER.

```
START OPERATION
▲→CHANGE SETPOINT
▼ Tset=65°C
```

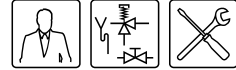

2. Use:

- ↑ to increase the value;
- ↓ to decrease the value.
- Confirm with **ENTER**. After confirming, the water heater enters "ONmode".

```
SETPOINT
  → 65°C
```

11.4.2 Setting water temperature during ON mode

The water temperature can also be directly adjusted when the water heater is in "ONmode". Simply use:

- ↑ to increase the value;
- ↓ to decrease the value.
- Confirm with **ENTER**.

```
ON
13:45 Thursday 65°C
      Tset→65°C
```

11.5 Week program

Using the week program, you can set the water temperature for the days and times you want.

If the appliance is running under a week program, then this is indicated on the display by the text **PROG** on the first line (see the figure). The second line shows the time of day, the day of the week and the temperature. The third line shows the next switching time of the week program and the programmed temperature. The fourth line shows the text **PROGRAM ACTIVATED**.

```
PROG
07:55 Monday 64°C
MO 08:00 Tset 75°C
PROGRAM ACTIVATED
```

The appliance's default week program switches the appliance on every day at 00:00 and off at 23:59. The default water temperature setting is 65°C.

If you want, you can change every setting in the appliance's standard week program.

If the water temperature becomes too low while the week program is running, the appliance will run through the heating cycle ([9.3 "The appliance's heating cycle"](#)) and return to the week program.

The following topics are covered here:

- [Starting and stopping the week program](#)
- [Changing the appliance's standard week program](#)
- [Adding times to a week program](#)
- [Deleting times from a week program](#)

11.6 Starting and stopping the week program

The week program can be started up from any other operating mode, as follows:

1. : WEEK PROGRAM | START OPERATION
Confirm with **ENTER**.

A week program can be shut down simply by activating a different operating mode, for example the "ON mode".

11.7 Changing the appliance's standard week program

Note

First fill-in the desired week program on the supplied week program card.

A week program is made up of a number of programmable periods in which you can have the appliance switch on and off. A period consists of:

- switch-on time: day of the week, hours and minutes;
- switch-off time: hours and minutes;
- the water temperature setting;
- on/off setting for a program-controlled pump.

Note

The switch-off time must always be followed by a switch-off time on the same day of the week. A maximum of **three** periods may be programmed per day. You can program a maximum of **21** periods.

Call up the menu for the week program as follows:

- : WEEK PROGRAM | PROGRAM OVERVIEW.
Confirm with **ENTER**.

```
WEEK PROGRAM
START OPERATION
↔PROGRAM OVERVIEW
▼
```



The display shows the menu for the week program, see the figure below. With the default setting, the program switches on and off every day at 00:00 and 23:59 respectively, the water temperature is 65°C and the pump is switched on (P).

	DAY	TIME	Tset	
ON	→SU	00:00	65°C	P
OFF	SU	23:59:00		
ON	MO	00:00	65°C	P
OFF	MO	23:59		
ON	TU	00:00	65°C	P
OFF	TU	23:59		
ON	WE	00:00	65°C	P
OFF	WE	23:59		
ON	TH	00:00	65°C	P
OFF	TH	23:59		
ON	FR	00:00	65°C	P
OFF	FR	23:59		
ON	SA	00:00	65°C	P
OFF	SA	23:59		
	INSERT			
	DELETE			
	START OPERATION			

Example

As an example, we will set the switch-on time for Sunday to 08:15 hours, and the matching switch-off time to 12:45 hours. The water temperature will be set to 75°C and the pump will run continuously. The following settings are entered one by one using the menus: the switch-on time, the switch-off time, the desired water temperature, and the mode of the program-controlled pump.

11.7.1 Week program: setting the switch-on time

1. Bring the cursor to SU
Confirm with ENTER.

ON	→SU	00:00		
OFF	SU	23:59		
Tset		65°C		
PUMP	ON		SAVE	

The day indicated by → blinks.

2. Use ↑ and ↓ to set the desired day. In the example this is SU (Sunday).
Confirm with ENTER.

ON	SU→	00:00		
OFF	SU	00:59		
Tset		65°C		
PUMP	ON		SAVE	

The cursor moves to the hour digits, which will blink.

3. Use ↑ and ↓ to set the hours. In the example, this is 08.

Confirm with ENTER.

The cursor moves to the minute digits, which will blink.

ON	SU	08→	00	
OFF	SU	08:00		
Tset		65°C		
PUMP	ON		SAVE	

Note

Because the switch-off time can never be earlier than the switch-on time, the switch-off time setting is automatically adjusted with the switch-on time.

4. Use ↑ and ↓ to set the minutes. In the example, this is 15.

Confirm with ENTER.

The cursor moves to the switch-off hour digits, which will blink.

ON	SU	08:15		
OFF	SU→	08:15		
Tset		65°C		
PUMP	ON		SAVE	

11.7.2 Week program: setting the switch-off time

1. Use ↑ and ↓ to set the hours. In the example, this is 12.

Confirm with ENTER.

The cursor moves to the minute digits, which will blink.

ON	SU	08:15		
OFF	SU	12→	15	
Tset		65°C		
PUMP	ON		SAVE	

2. Use ↑ and ↓ to set the minutes. In the example, this is 45.

Confirm with ENTER.

The cursor moves to the desired water temperature.

ON	SU	08:15		
OFF	SU	12:45		
Tset→		65°C		
PUMP	ON		SAVE	



11.7.3 Week program: setting the water temperature

1. Use \uparrow and \downarrow to set the water temperature. In the example this is 75°C.

Confirm with **ENTER**.

The cursor moves to **PUMP ON**.

```
ON  SU 08:15
OFF SU 12:45
Tset 75°C
PUMP→ON  SAVE
```

11.7.4 Week program: setting the program-controlled pump

1. If required, a pump can be controlled during the period. Use \uparrow and \downarrow to set **PUMP ON**. The pump ensures a regular circulation of hot water in the hot water pipes. You can skip this step if you there is no pump in your hot water circuit.

Confirm with **ENTER**.

The cursor moves to **SAVE**.

```
ON  SU 08:15
OFF SU 12:45
Tset 75°C
PUMP ON →SAVE
```

2. Confirm with **ENTER**.

The display shown in the figure will appear.

```
DAY TIME Tset
ON →SU 08:15 75°C P
OFF SU 12:45
ON MO 00:00 65°C P
OFF MO 23:59
ON TU 00:00 65°C P
OFF TU 23:59
```

3. If you wish, you can use \downarrow to scroll to another day, and change more switch-on ([11.7.1 "Week program: setting the switch-on time"](#)) and switch-off ([11.7.2 "Week program: setting the switch-off time"](#)) times.

4. After changing all desired switch-on and switch off times, you can start running the week program:

Scroll with \downarrow to **START OPERATION**.

Confirm with **ENTER**.

11.8 Adding times to a week program

Call up the menu to **INSERT** switch-on and switch-off times into a week program as follows:

1. \leftarrow **WEEK PROGRAM | PROGRAM OVERVIEW**.

Confirm with **ENTER**.

```
WEEK PROGRAM
START OPERATION
↔PROGRAM OVERVIEW
▼
```

The display shows the menu for the week program. The cursor points to the active period.

```
DAY TIME Tset
ON →SU 08:15:00 75°C P
OFF SU 12:45:00
ON MO 00:00 65°C P
.....
.....
OFF SA 23:59
INSERT
DELETE
START OPERATION
```

2. Scroll \downarrow to **INSERT**.

Confirm with **ENTER**.

The submenu for adding a period will appear.

```
ON →SU 08:15
OFF SU 12:45
Tset 75°C
PUMP ON      SAVE
```

Example

As an example, we will program an extra period in which the switch-on time is set to 18:00 and the corresponding switch-off time to 22:00. The water temperature will be set to 75°C and the pump will run continuously.

```
DAY TIME Tset
ON →SU 18:00 75°C P
OFF SU 22:00
ON MO 00:00 65°C P
OFF MO 23:59
.....
.....
OFF SA 23:59
INSERT
DELETE
START OPERATION
```



3. Proceed as follows:
 - a. Set the switch-on time (11.7.1 "Week program: setting the switch-on time").
 - b. Set the switch-off time (11.7.2 "Week program: setting the switch-off time").
 - c. Set the water temperature (11.7.3 "Week program: setting the water temperature").
 - d. Set the program-controlled pump (11.7.4 "Week program: setting the program-controlled pump").
5. To activate the week program with the new period added, scroll down with ↓ to START OPERATION and confirm with ENTER.

11.9 Deleting times from a week program

All switch-on/off times are shown sequentially in the display. Assume that the switch-on/off times for the water heater are programmed as in the figure.

```

DAY TIME Tset
ON →SU 08:15 75°C P
OFF SU 12:45
ON SU 18:00 75°C P
OFF SU 22:00
.....
.....
OFF SA 23:59
INSERT
DELETE
START OPERATION
  
```

To delete a period, proceed as follows:

1. WEEK PROGRAM | PROGRAM OVERVIEW.
Confirm with ENTER.

```

MENU
OFF
↑→ON
▼ WEEK PROGRAM
  
```

2. Scroll with ↓ to PROGRAM OVERVIEW.
Confirm with ENTER.

```

WEEK PROGRAM
START OPERATION
↑→PROGRAM OVERVIEW
▼
  
```

The display shows the menu for the week program.

3. Scroll with ↓ to DELETE.

Confirm with ENTER.

To warn you that you are now working in the delete sub-menu, the cursor is replaced with an exclamation mark (!) and the period settings will blink.

```

DAY TIME Tset
ON !SU 08:15 75°C P
OFF SU 12:45
ON SU 18:00 75°C P
OFF SU 22:00
.....
.....
OFF SA 23:59
INSERT
DELETE
START OPERATION
  
```

4. Scroll with ↓ to the day to be deleted. For example, SU (Sunday) in the second period. See the figure.

Confirm with ENTER.

```

DAY TIME Tset
ON !SU 18:00 75°C P
OFF SU 22:00
ON MO 00:00 65°C P
OFF MO 23:59
.....
.....
OFF SA 23:59
INSERT
DELETE
START OPERATION
  
```

5. The lines showing switch-on/off times are replaced by the text DELETE BLOCK?. See the figure.

Confirm with ENTER.

(or use RESET to cancel)

```

DAY TIME Tset
ON ! DELETE
OFF BLOCK?
ON MO 00:00 65°C P
  
```



The switching period has been deleted. You will return now to the week program menu. The cursor points to the first programmed period.

```

DAY TIME Tset
ON →SU 08:15 75°C P
OFF SU 12:45
ON MO 00:00 65°C P
OFF MO 23:59
.....
OFF SA 23:59
INSERT
DELETE
START OPERATION
  
```

6. Scroll with **↓** to **START OPERATION**.
Confirm with **ENTER**.
The week program is active.

11.10 Extra period

Use an extra period when you either want to have the water heater switch on and off for a certain period, either without modifying the active week program, or without taking the water heater out of OFF mode (frost protection active).

If the water heater is running under an "extra period", then this is indicated in the display with the text **EXTRA**.

```

EXTRA
10:00 Monday 76°C
MO 11:15 Tset 75°C
PERIOD ACTIVATED
  
```

During the extra period (11.10.1 "Programming an extra period"), if the water temperature becomes too low, the water heater will run through the operating cycle (9.3 "The appliance's heating cycle"), then return to the extra period.

The same settings can be made for an extra period as for a week program (11.7 "Changing the appliance's standard week program").

11.10.1 Programming an extra period

1. Call up the menu for entering an extra period via:
2. **EXTRA PERIOD**
Confirm with **ENTER**.

```

MENU
ON
← WEEK PROGRAM
→ EXTRA PERIOD
  
```

The display show the settings for the extra period.

Setting the switch-on time

1. Use **↑** and **↓** to set the day. In the example this is **SU**.

Confirm with **ENTER**.

The cursor moves to the hour digits, which will blink.

```

ON SU→00:00
OFF SU 00:59
Tset 65°C
PUMP ON START
  
```

2. Use **↑** and **↓** to set the switch-on hour to the desired value. In the example, this is **08**.

Confirm with **ENTER**.

The cursor moves to the minute digits, which will blink.

```

ON SU 08→00
OFF SU 08:00
Tset 65°C
PUMP ON START
  
```

Note

Because the switch-off time can never be earlier than the switch-on time, the switch-off time setting is automatically adjusted with the switch-on time.

3. Use **↑** and **↓** to set the minutes. In the example, this is **15**.

Confirm with **ENTER**.

The cursor moves to the hour digits of the switch-off period.

```

ON SU 08:15
OFF SU→08:15
Tset 65°C
PUMP ON START
  
```

Setting the switch-off time

1. Use **↑** and **↓** to set the hours. In the example, this is **12**.

Confirm with **ENTER**.

The cursor moves to the minute digits, which will blink.

```

ON SU 08:15
OFF SU 12→15
Tset 65°C
PUMP ON START
  
```



- Use **↑** and **↓** to set the minutes. In the example, this is 45.

Confirm with **ENTER**.

The cursor moves to the water temperature. See the figure

```
ON  SU 08:15
OFF SU 12:45
Tset→65°C
PUMP ON  START
```

Setting the water temperature

- Use **↑** and **↓** to set the water temperature. In the example this is 75°C.

Confirm with **ENTER**.

The cursor moves to PUMP ON

```
ON  SU 08:15
OFF SU 12:45
Tset 75°C
PUMP→ON START
```

Setting the program-controlled pump

- If required, a pump can be controlled during the period. Use **↑** and **↓** to set PUMP ON. The pump ensures a regular circulation of hot water in the hot water pipes. You can skip this step if you there is no pump in your hot water circuit.

Confirm with **ENTER**.

The cursor moves to START.

```
ON  SU 08:15
OFF SU 12:45
Tset 75°C
PUMP ON →START
```

- Confirm with **ENTER**.

The extra period has been programmed.

Note

Once the extra period has completed running, the controller returns to the mode ON, OFF or WEEK PROGRAM. The following week, the extra period will **NOT** be automatically switched back on.

11.11 Settings

Using the option **SETTINGS** you can adjust certain settings, and display certain water heater specifications:

- **Adjustable settings**

- Menu language.
- Current day of week and time.

- **Displayable water heater specifications**, this category is only relevant to the installation engineer and/or service and maintenance engineer

- Regulation interval (water temperature).
- Ignition speed of fan.
- Working speed of fan.

11.11.1 Setting menu language

To set menu language:

```
MENU
WEEK PROGRAM
▲ EXTRA PERIOD
▼→SETTINGS
```

- Call up the menu for selecting the language as follows:

- ☰**: SETTINGS.

Confirm with **ENTER**.

The display shows the menu for settings.

```
SETTINGS
→LANGUAGE
▲ DAY/TIME
▼ SPECIFICATIONS
```

- The cursor is positioned beside LANGUAGE

Confirm with **ENTER**.

The display shows the language selection menu.

```
LANGUAGE
ENGLISH
▲ NEDERLANDS
▼→DEUTSCH
FRANCAIS
ITALIANO
CZECH
ESPANOL
```

- Scroll with **↓** to the desired language.

Confirm with **ENTER**.

The language is set.



11.11.2 Setting day and time

To enter the time and day:

```
MENU
WEEK PROGRAM
^ EXTRA PERIOD
v->SETTINGS
```

1. Call up the menu for entering the day and time as follows:
2. : SETTINGS.
Confirm with **ENTER**.
The display shows the menu for settings.
3. Scroll with **↑** and **↓** to DAY/TIME
Confirm with **ENTER**.

```
SETTINGS
LANGUAGE
^>DAY/TIME
v SPECIFICATIONS
```

The display shows the sub-menu for adjusting the day.

```
DAY
->Sunday
^ Monday
v Tuesday
Wednesday
Thursday
Friday
Saturday
```

4. The cursor is positioned beside *Sunday*.
Scroll with **↑** and **↓** to the desired day.
Confirm with **ENTER**.
The day has been set. The display shows the sub-menu for adjusting the time.

```
TIME
->00:00
```

5. The cursor moves to the hour digits, which will blink.
Scroll with **↑** and **↓** to the current hour, for example 15.
Confirm with **ENTER**.

```
TIME
15->00
```

6. The cursor moves to the minute digits, which will blink.
Scroll with **↑** and **↓** to the next minute, for example 45.
Confirm the minute setting with **ENTER**

```
TIME
15->45
```

The time has been set.

Note
The water heater takes no account of daylight saving.

11.11.3 Displaying water heater specifications

Note
This category is solely intended for the installation engineer and/or service and maintenance engineer.

Call up the menu to display the water heater specifications as follows:

1. : SETTINGS.
Confirm with **ENTER**.

```
MENU
WEEK PROGRAM
^ EXTRA PERIOD
v->SETTINGS
```

2. Scroll with **↓** to SPECIFICATIONS
Confirm with **ENTER**.

```
SETTINGS
LANGUAGE
^ DAY/TIME
v->SPECIFICATIONS
```

The display shows the sub-menu for displaying water heater specifications.

```
SPECIFICATIONS
->REGULATION INTERVAL
^ IGNITION SPEED
v WORKING SPEED
```

3. Scroll with **↓** to the section to be displayed, for example **REGULATION INTERVAL**.
The corresponding display appears.

```
REGULATION INTERVAL
40-80°C
```

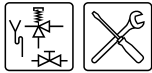

12 Service program

12.1 Introduction

The service program is used by the installation engineer or service and maintenance engineer for:

- [Displaying the water heater history](#)
- [Displaying the error history](#)
- [Displaying the water heater history](#)
- [Display the selected water heater](#)
- [Switching the pump on or off](#)
- [Setting the service interval](#)
- [Service mode](#)
- [Setting legionella prevention](#)
- [Solar heating system configuration](#)
- [Setting the central heating configuration](#)

```
SERVICE MENU
→HYSTERESIS
▲ ERROR HISTORY
▼ APPLIANCE HISTORY

SELECT APPLIANCE
PUMP RELAY
SERVICE INTERVAL
SERVICE OPERATION
ANTI LEGIONELLA
SETTINGS SOLAR
SETTINGS HEATING
```

These sub-menus are briefly described in the following paragraphs. If you are not generally familiar with the use of the displays and menus, first read the relevant chapter ([7 "The control panel"](#)).

Note

The notation convention for the service menu is identical to that of the main menu ([11.2 "Notation convention for menu-related instructions"](#)). The difference is, you use \Rightarrow to bring up the service program, instead of \Rightarrow which brings up the main menu.

12.2 Setting the hysteresis

Call up the menu to set the hysteresis as follows:

\Rightarrow : HYSTERESIS DOWN

```
HYSTERESIS DOWN →3°C
```

Please refer to the table ([3.4.2 "General and electrical specifications"](#)) for the regulation interval and settings for each water heater.

12.3 Displaying the error history

Display the error history as follows:

- \Rightarrow : ERROR HISTORY

The controller will display an overview of "Blocking errors" and "Lock out errors". In both cases, note that the controller reserves 15 lines for the last 15 error messages. If there are fewer than 15 error messages, an ellipsis (...) is displayed. The display first shows the "Blocking errors". When ENTER is pressed, the "Lock out errors" are then displayed.

The figure shows an example of "Blocking errors". In this case, the text ERROR HISTORY is followed by (B).

```
ERROR HISTORY(B)
S04 SENSOR ERROR
F06 IONIZATION
▼ CO2 50 HZ ERROR
```

The figure shows an example of "Lock out errors". In this case, the text ERROR HISTORY is followed by (L).

```
ERROR HISTORY(L)
F02 FAN
F07 FLAME ERROR
▼ ...
```

Note

For an overview of all errors and the possible causes, please refer to the relevant chapter ([13 "Errors"](#)).

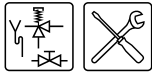

12.4 Displaying the water heater history

The water heater history sub-menu is used to display the burning hours, the number of ignitions, the number of flame errors and the number of ignition errors.

Call up the menu for displaying the water heater history as follows:

- \Rightarrow : APPLIANCE HISTORY

The figure shows an example.

```

APPLIANCE HISTORY
  BURNINGHOURS 000410
^IGNITIONS    001000
vFLAME ERRORS 000021
IGNIT ERROR   000013
  
```

12.5 Display the selected water heater

Call up the menu for displaying the water heater selection as follows:

- \Rightarrow : SELECT APPLIANCE

The water heater number can be found on the rating plate.

The water heater selection has been correctly preset in the factory.

```

SELECT APPLIANCE
^5934
^ 8576
v 3379
6527
....
  
```

12.6 Switching the pump on or off

If a program-controlled pump is installed ([3.11.5 "Connecting a program-controlled pump"](#)), it can be switched ON or OFF as follows:

- \Rightarrow : PUMP RELAY

The standard setting for the pump relay is OFF.

```

PUMP RELAY
^ON
OFF
  
```

If the mode WEEK PROGRAM or EXTRA PERIOD is active, then the setting for mode WEEK PROGRAM or EXTRA PERIOD has priority over the ON/OFF selection for the pump relay in the service menu.

Example

One of the week program periods is currently active. During this period, the pump relay setting is OFF. If the pump relay is set ON in the service menu, the pump will nonetheless remain OFF. The pump will only switch ON once the week program period has ended.

12.7 Setting the service interval

The service interval is a feature of the controller to help the service and maintenance engineer set the frequency of maintenance ([14.2 "Determining service interval"](#)).

The service interval is determined by the number of months that the appliance has been running. This can be set to 6, 9 and 12 months. The default service interval is 12 months. When the preset number of hours has been reached, an appropriate message ([8.4 "Service condition"](#)) will appear. Set the service interval as follows:

- \Rightarrow : SERVICE INTERVAL

```

SERVICE INTERVAL
  6
  9 Months
^12
  
```

12.8 Service mode

The Installation engineer uses the SERVICE OPERATION menu to adjust the water heater CO₂ setting during FULL LOAD and PARTIAL LOAD operation.

Use \Rightarrow :SERVICE OPERATION to display the SERVICE OPERATION menu.

```

SERVICE OPERATION
^FULL LOAD
PARTIAL LOAD
  
```

\downarrow and \uparrow can be used to switch between PARTIAL LOAD and FULL LOAD.

If there is a heat demand, the water heater will first run through a startup cycle, then continue to operate in FULL LOAD or PARTIAL LOAD mode.

If there is no heat demand, the installation engineer must create one. This can be done by draining the water heater until it is cold or by temporarily raising the set point using \uparrow . After adjustment, the set point must be set back to the original value using \downarrow .

if you exit the SERVICE OPERATION menu or if no buttons are pressed for a period of 15 minutes, the water heater will revert to the original operating mode.

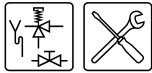

Temporarily raising the setpoint during FULL LOAD or PARTIAL LOAD

1. \Rightarrow :SERVICE OPERATION.

```
SERVICE OPERATION
→FULL LOAD
PARTIAL LOAD
```

2. Select FULL LOAD or PARTIAL LOAD. The example below describes the situation for FULL LOAD, which is identical to that for PARTIAL LOAD.

3. Confirm with ENTER.

```

    ↑  ⊙  ←  →  ⊗  ⊞  ↓
SERVICE  ▾          ▾ ▾
FULL LOAD          47°C
                Tset 65°C
RUNNING
```

4. To create a heat demand, you can temporarily raise the set point using \uparrow to e.g. 70°C.

```

    ↑  ⊙  ←  →  ⊗  ⊞  ↓
SERVICE  ▾          ▾ ▾
FULL LOAD          47°C
                Tset 70°C
RUNNING
```

5. Confirm with ENTER.
6. After adjusting for the CO₂ value (3.13.3 "CO₂ adjustment"), you must use \uparrow to restore the set point to its original value.
7. Press \Rightarrow twice to return to the MENU menu via the SERVICE OPERATION menu.

```
MENU
→OFF
← ON
▼ WEEK PROGRAM
EXTRA PERIOD
SETTINGS
```

12.9 Setting legionella prevention

To prevent infection with legionella bacteria, the water heater heats the water to 65 °C once per week, for 1 hour. This period is adjustable. By default, this period is set to Monday from 02:00 to 03:00 hours.

12.9.1 Switching legionella prevention on and off

To switch legionella prevention on or off, select:

- \Rightarrow : ANTI LEGIONELLA

```
ANTI LEGIONELLA
→YES
NO
```

- Select NO to switch legionella prevention off.
- Select YES to switch legionella prevention on. The following screen appears:

```
ON MO 02:00 LEG
OFF MO 03:00
Tset 65°C
→START Change
```

- Select START to activate the period currently displayed.

The following display appears. This display indicates that legionella prevention is switched on.

```

    ↑  ⊙  ←  →  ⊗  ⊞  ↓
LEG      ▾          ▾ ▾
02:45 Monday 60°C
MO 03:00 Tset 65°C
RUNNING
```

12.9.2 Changing legionella prevention start time

If you wish to change the start time, select:

- \Rightarrow : ANTI LEGIONELLA | YES | Change

The following display appears.

```
ON →MO 02:00 LEG
OFF MO 03:00
Tset 65°C
START
```

- Now set the day and time the same way as described for setting an extra period in the week menu (11.10.1 "Programming an extra period"). In this case however, the pump will be automatically started.
- Select START to start.

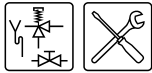

12.10 Solar heating system configuration

Use the solar heating system settings menu to reach the menus shown here:

```
SETTINGS SOLAR
→DRAIN BACK
← TEST SOLAR PUMP
→ SOLAR DIFFERENCE

Q/T SENSOR
SOLAR LIMIT
CONTRIBUTION
TEMPERATURES
```

12.10.1 Setting the drain-back tank

Use this menu to specify whether the solar heating system is equipped with a drain-back tank for the heating fluid. Call up the menu as follows:

- \Rightarrow : SETTINGS SOLAR | DRAIN BACK

The default is NO.

```
DRAIN BACK
YES
→NO
```

Note

During commissioning, it is important to check whether this setting corresponds with the configuration of the solar heating system.

12.10.2 Switching on the solar pump

This menu lets you switch on the pump in the solar heating system manually. Call up this menu as follows:

- \Rightarrow : SETTINGS SOLAR | TEST SOLAR PUMP

The following display appears.

```
TEST SOLAR PUMP
→START
```

When START is selected, the pump will start to run for two minutes. Once the 2 minutes have elapsed, the pump stops running again.

12.10.3 Setting the solar limit

The solar limit temperature is the maximum water temperature obtained in the appliance via the solar heating system (measured by sensor T_1).

This value can be set between 65 and 80°C. The default value is 65°C.

If you set the solar limit higher than the set point (11.4 "Setting the water temperature"), then the solar pump will be started in order to heat the water further once the set point has been reached. However, this only makes sense if the solar heating system is

actually generating heat. This makes use of the difference between the temperature at the top of the solar collector (S_1) and that in the appliance (measured by S_2).

Call up the menu for the solar limit as follows:

- \Rightarrow : SETTINGS SOLAR | SOLAR LIMIT

```
SOLAR LIMIT
65°C
```

Please refer to the table (3.4.2 "General and electrical specifications") for the adjustment range and default value for each appliance.

12.10.4 Setting the solar difference

The solar difference is a value that influences how the operating cycle of the water heater proceeds. Call up the menu as follows:

- \Rightarrow : SETTINGS SOLAR | SOLAR DIFFERENCE

```
SOLAR DIFFERENCE
5°C
```

Please refer to the table (3.4.2 "General and electrical specifications") for the regulation interval and default value for each water heater.

12.10.5 Setting the Q/T sensor

The energy contribution of the solar heating system can be calculated (12.10.6 "Displaying contribution") using the Q/T sensor. This calculation is only possible if your installation is equipped with such a Q/T sensor. If this is the case, then you must set this value to YES, otherwise NO. Call up the corresponding menu as follows:

- \Rightarrow : SETTINGS SOLAR | Q/T SENSOR

```
Q/T SENSOR
YES
→NO
```

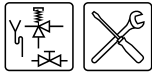

12.10.6 Displaying contribution

This option enables you to read out how much energy the solar heating system supplies. For this data to be displayed, the installation must be equipped with a Q/T sensor ([12.10.5 "Setting the Q/T sensor"](#)).

Three values are reported on the display:

- ACTUAL, actual energy: the amount of energy currently being supplied.
- LAST 24hr, energy supplied over last 24 hours.
- TOTAL, total energy supplied since day 1.

Call up this menu as follows:

- : SETTINGS SOLAR | CONTRIBUTION

CONTRIBUTION	
ACTUAL	00000 kW
LAST 24hr	00000 kJ
TOTAL	00000 MJ

12.10.7 Displaying temperatures

This option lets you read what the solar heating system's sensors are recording. Two values are reported on the display:

- S1, temperature in the collector.
- S2, temperature between the inlet and outlet of the heat exchanger in the tank.

Call up this menu as follows:

- : SETTINGS SOLAR | TEMPERATURES

TEMPERATURES	
S1	84°C
S2	45°C

12.11 Setting the central heating configuration

Use this menu to specify whether a central heating system is connected to the installation.

Note
This function is not yet available.

- : SETTINGS HEATING

SETTINGS HEATING	



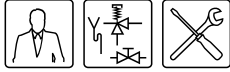

13 Errors

13.1 Introduction

A distinction is made between:

- **General errors**

General errors are not reported on the display. General errors are:

- Gas smell
- Display does not light up
- Insufficient or no hot water.
- Water leakage
- Explosive ignition.

The manual includes ([13.2 "Troubleshooting table for general errors"](#)) a table with general errors.

- **Displayed errors**

Errors are reported on the display as follows:

- Line one: an error code and a brief description. The code consists of a letter and two digits.
- Lines two, three and four: a long description, alternating with a recommended action. See the figures. The first shows a possible error, the second shows the appropriate checking action.

```
S02: SENSOR ERROR
      TOP TANK
      SENSOR 1
      NOT CONNECTED
```

```
S02: SENSOR ERROR
      CHECK TOP TANK
      SENSOR
```

There are various types of errors, all falling into one of two groups:

- **LOCK OUT ERRORS**
When the cause has been removed, these errors require a reset with the **RESET** button, before the water heater can resume operation.
- **BLOCKING ERRORS**
These errors disappear automatically once the cause of the error has been removed, after which the water heater resumes operation by itself.

The manual includes ([13.3 "Troubleshooting table for displayed errors"](#)) a table of error messages that can appear on the display.

- **Warnings on the display**

The warnings ([13.4 "Warnings on the display"](#)) apply to the water heater.

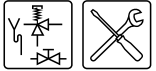

13.2 Troubleshooting table for general errors

Warning
Maintenance may only be performed by a qualified service and maintenance engineer.

General errors

Indication	Cause	Measure	Remark
Gas smell	Gas leak	<p>Warning Close the main gas valve at once.</p> <p>Warning Do not operate any switches.</p> <p>Warning No naked flames.</p> <p>Warning Ventilate the boiler room.</p>	<p>Warning Immediately contact your installation engineer or local gas company.</p>
The display is off	The water heater is off	Start the water heater (9 "Starting the water heater")	
	No supply voltage present	<ol style="list-style-type: none"> 1. Check whether the isolator is ON. 2. Check that there is power to the isolator. 3. Check whether the ON/OFF switch of the controller is ON (position I). 4. Check whether there is power to the electrical connector block. 5. The measured voltage must be 230 V_{AC} (-15%, +10%) 	See the electrical diagram (17 "Appendices"). If the error persists, consult your installation engineer.
	Defective fuse(s)	Replace fuse(s)	To replace the fuses, you must contact your installation engineer.

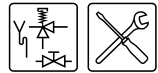

Indication	Cause	Measure	Remark
Water leakage	Leakage from a water connection (threaded)	Tighten the threaded connection	If the leak persists, consult your installation engineer
	Condensate leakage	Check that the condensation water discharge is working properly. Rectify if necessary	
	Leakage from another nearby water water heater or pipe segment	Trace the leak	
	Leakage from the water heater tank	Consult the supplier and/or manufacturer	
Explosive ignition	Incorrect supply pressure and/or CO ₂	Set (3.13 " <u>Check the supply pressure, gas control valve pressure, CO₂ value and switching pressure</u> ") the correct supply pressure and/or CO ₂ .	If ignition is not improved, consult your installation engineer.
	Contaminated burner	Clean the burner (15.4.2 " <u>Cleaning the burner</u> ")	
Insufficient or no hot water	The water heater is off	Start the water heater (9 " <u>Starting the water heater</u> ")	
	No supply voltage present	<ol style="list-style-type: none"> 1. Check whether the isolator is ON. 2. Check that there is power to the isolator. 3. Check whether the ON/OFF switch of the controller is ON (position I). 4. Check whether there is power to the electrical connector block. 5. The measured voltage must be 230 V_{AC} (-15%, +10%) 	See the electrical diagram (17 " <u>Appendices</u> "). If the error persists, consult your installation engineer.
	Hot water supply is used up	Reduce hot water consumption and give the water heater time to heat up.	If there continues to be insufficient or no hot water, consult your installation engineer.
	The controller is in the OFF position.	Switch the controller to the ON position (11.3 " <u>Switching to "ON mode"</u> ").	
	Temperature (T _{set}) is set too low.	Set temperature (T _{set}) to a higher setting (11.4 " <u>Setting the water temperature</u> ").	

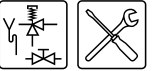

Indication	Cause	Measure	Remark
Glycol leakage	Leakage from a fluid connection (threaded)	Tighten the threaded connection.	If the leak persists or a component needs replacement, consult your installation engineer
	Leakage from a component	1. Tighten component joints 2. Any defective components must be replaced	
	Leakage from solar heating system	Consult the supplier and/or manufacturer	

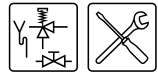

13.3 Troubleshooting table for displayed errors

Displayed errors

Code + description	Cause	Measure	Remark
S01 (blocking error) Open circuit from temperature sensor T ₂ at the bottom of the tank.	Sensor is not (correctly) connected	Connect the sensor lead to JP3	See the electrical diagram (17 "Appendices").
	Damaged cable and/or defective sensor	Replace the cable and/or sensor.	To replace the necessary parts, you must contact your installation engineer
S02 (blocking error) Open circuit from sensor 1 of temperature sensor T ₁ at the top of tank ⁽¹⁾ .	Sensor is not (correctly) connected	Connect the sensor lead to JP5	See the electrical diagram (17 "Appendices").
	Damaged cable and/or defective sensor	Damaged cable and/or defective sensor	To replace the necessary parts, you must contact your installation engineer
S03 (blocking error) Open circuit in sensor 2 of temperature sensor T ₁ at the top of the tank ⁽¹⁾ .	Sensor is not (correctly) connected	Connect the sensor lead to JP5	See the electrical diagram (17 "Appendices").
	Damaged cable and/or defective sensor	Replace the cable and/or sensor.	To replace the necessary parts, you must contact your installation engineer
S04 (blocking error) Open circuit from dummy 1	Dummy is not (correctly) connected	Connect the dummy sensor (dummy sensor 1 and 2) leads to JP4.	See the electrical diagram (17 "Appendices").
	Defective dummy	Replace the dummy sensor	To replace the necessary parts, you must contact your installation engineer
S05 (blocking error) Open circuit from dummy 2	Dummy is not (correctly) connected	Connect the dummy sensor (dummy sensor 1 and 2) leads to JP4.	See the electrical diagram (17 "Appendices").
	Defective dummy	Replace the dummy sensor	To replace the necessary parts, you must contact your installation engineer

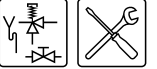

Code + description	Cause	Measure	Remark
S07 (blocking error) Open circuit from temperature sensor S_2 at the bottom of the tank.	Sensor is not (correctly) connected	Connect the sensor lead to J14 (ports 2 and 4) of the solar controller	See the electrical diagram (17 "Appendices").
	Damaged cable and/or defective sensor	Replace the cable and/or sensor.	To replace the necessary parts, you must contact your installation engineer
S08 (blocking error) Open circuit from temperature sensor S_1 in the collector.	Sensor is not (correctly) connected	Connect the sensor lead to J13 (ports 2 and 4) of the solar controller	See the electrical diagram (17 "Appendices").
	Damaged cable and/or defective sensor	Replace the cable and/or sensor.	To replace the necessary parts, you must contact your installation engineer
S11 (blocking error) Short circuit in temperature sensor T_2 at the bottom of the tank.	Short circuit in sensor circuit	Replace the cable and/or sensor.	To replace the necessary parts, you must contact your installation engineer
S12 (blocking error) Short circuit in sensor 1 of temperature sensor T_1 at top of tank ⁽¹⁾	Short circuit in sensor circuit	Replace the cable and/or sensor.	To replace the necessary parts, you must contact your installation engineer
S13 (blocking error) Short circuit in sensor 2 of temperature sensor T_1 at the top of the tank ⁽¹⁾ .	Short circuit in sensor circuit	Replace the cable and/or sensor.	To replace the necessary parts, you must contact your installation engineer
S14 (blocking error) Short circuit from dummy 1	Short circuit in sensor circuit	Replace the dummy sensor ⁽²⁾	To replace the necessary parts, you must contact your installation engineer

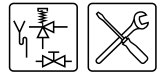

Code + description	Cause	Measure	Remark
S15 (blocking error) Short circuit from dummy 2	Short circuit in sensor circuit	Replace the dummy sensor ⁽²⁾	To replace the necessary parts, you must contact your installation engineer
S17 (blocking error) Short circuit from temperature sensor S ₂ at the bottom of the tank.	Short circuit in sensor circuit	Replace the cable and/or sensor.	To replace the necessary parts, you must contact your installation engineer
S18 (blocking error) Short circuit from temperature sensor S ₁ in the collector.	Short circuit in sensor circuit	Replace the cable and/or sensor.	To replace the necessary parts, you must contact your installation engineer
F01 (blocking error) Defect in power supply circuit	Live and neutral connected wrong way around.	Be sure to connect the live and neutral correctly (3.11 "Electrically connecting the water heater"); the water heater is phase-sensitive	See the electrical diagram (17 "Appendices").
	Condensation on the flame probe	<ol style="list-style-type: none"> 1. Disconnect the lead at the flame probe 2. Ignite the water heater three times, with an interrupted ionisation circuit 3. Reconnect the ionisation lead to the flame probe 4. Ignite the water heater again 5. The repeated ignition attempts will have caused the condensation to evaporate 	If errors persist, contact your installation engineer
	Floating neutral	Install an isolating transformer (3.11.4 "Isolating transformer")	Contact your installation engineer to have an isolating transformer installed
F02 (lock out error) Fan fails to run at correct speed.	Defective motor and/or rotor.	<ol style="list-style-type: none"> 1. Check the motor and rotor 2. Replace the fan if the motor or rotor is defective. 3. Reset controller 	<p>See the electrical diagram (17 "Appendices").</p> <p>To have the wiring replaced and a new fan fitted, you must contact your installation engineer</p>

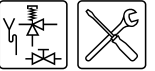

Code + description	Cause	Measure	Remark
	Damaged wiring	<ol style="list-style-type: none"> 1. Check the wiring between the fan and the controller. 2. If any wires are damaged, the wiring harness must be replaced. 3. Reset controller 	
	Contaminated or blocked fan	<ol style="list-style-type: none"> 1. Check if the fan is dirty and repair it if necessary. 2. Check that the rotor can rotate freely 3. Reset controller 	If the error cannot be resolved or is persistent, contact your installation engineer
	Because of a drop in the supply voltage, the fan will not run at the correct speed.	<ol style="list-style-type: none"> 1. Check the supply voltage, this must be 230 V_{Ac}(-15%, +10%) 2. Reset controller 	

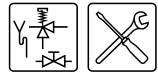

Code + description	Cause	Measure	Remark
F03 (lock out error) The pressure switch fails to work correctly	Damaged wiring/Open circuit	<ol style="list-style-type: none"> 1. Check the wiring between the pressure switch and the controller 2. If necessary, replace the wiring 	If the error cannot be resolved or is persistent, contact your installation engineer To replace the necessary parts, you must contact your installation engineer
	Pressure switch not closing	<ol style="list-style-type: none"> 1. Check the speed of the fan (<u>3.4.2 "General and electrical specifications"</u>). 2. Check that the hoses on the pressure switch and the air supply hose between fan and burner are correctly fitted. Refit them if necessary 3. Check for cracks in the hoses on the pressure switch and in the air supply hose between fan and burner. If necessary, replace the hoses. 4. Check whether the chimney flue is compliant (<u>3.10 "Air supply and chimney flue discharge"</u>). 5. Check for blockage in the chimney flue. Remove any blockage that may be present 6. Check for blockage in the condensation water discharge. Remove any blockage that may be present. 7. Measure the pressure differential across the pressure switch. See the table (<u>3.4.2 "General and electrical specifications"</u>). If there is insufficient pressure differential, clean the heat exchanger. If the pressure differential is acceptable, check that the pressure switch is closing, using a multimeter. 	

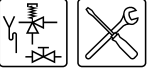

Code + description	Cause	Measure	Remark
F04 (lock out error) Three unsuccessful ignition attempts.	No gas	<ol style="list-style-type: none"> 1. Open the main gas supply valve and/or the manual gas supply valve before the gas control valve 2. Check supply pressure to the gas control valve 3. If necessary, restore the gas supply 	To restore the gas supply, contact your installation engineer
	Air in the gas pipes	Bleed the air out of the gas pipe (3.13 "Check the supply pressure, gas control valve pressure, CO ₂ value and switching pressure")	See Checking the supply pressure and burner pressure (3.13 "Check the supply pressure, gas control valve pressure, CO ₂ value and switching pressure") for how to bleed air from the gas line and how to measure the supply pressure and burner pressure. To replace the necessary parts, you must contact your installation engineer
	Defect in the hot surface igniter circuit	<ol style="list-style-type: none"> 1. Check that the hot surface igniter is correctly connected (JP2). 2. Check the wiring of the hot surface igniter. 3. Measure the resistance across the hot surface igniter. This must lie between 2 and 10 Ohm (at room temperature). 4. Check that the hot surface igniter lights up during ignition. 5. If necessary, replace the hot surface igniter. 	If the error persists, contact your installation engineer. To replace the necessary parts, you must contact your installation engineer
	Defect in the ionisation circuit	<ol style="list-style-type: none"> 1. Check that the flame probe is correctly connected (JP2) 2. Check the wiring of the flame probe 3. Measure the ionisation current. This must be a minimum of 1.5 microA. 4. If necessary, replace the wiring. 	
	Supply voltage too low	Check the supply voltage, this must be 230 V _{AC} (-15%, +10%)	
F05 (lock out error) Too many flame errors have been signalled.	Incorrect roof or wall flue terminal. Recirculating flue gases.	<ol style="list-style-type: none"> 1. Check that the correct roof or wall flue terminal has been installed (3.10 "Air supply and chimney flue discharge"). 2. If necessary, install the correct roof or wall flue terminal. 3. Check that the roof or wall flue terminal discharges into a permitted area. 	If the error cannot be resolved or is persistent, contact your installation engineer

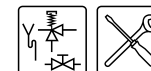

Code + description	Cause	Measure	Remark
F06 (blocking error) Short circuit between flame probe and earth	Damaged cable in contact with metal surface or bent flame probe.	Check the wiring and the flame probe. Replace the wiring and/or flame probe if necessary.	If the error persists, contact your installation engineer. To replace the necessary parts, you must contact your installation engineer
	Ceramic part of the flame probe is broken/cracked.	1. Check whether the ceramic part of the flame probe is still intact, in the vicinity of the air distribution plate of the burner. 2. If not the flame probe must be replaced.	
F07 (lock out error) A flame has been detected after the gas control valve was closed.	Defective gas control valves	1. Check whether there is still burner pressure present, after the gas control valves have closed. 2. Check whether a flame is still present, after the gas control valves have closed. 3. If this is the case, the gas control valve must be replaced.	If the error cannot be resolved or is persistent, contact your installation engineer To replace the necessary parts, you must contact your installation engineer
F08 (lock out error) Error message from safety relay	Flame detection before the gas control valve opened.	1. Reset controller. 2. If the error appears again, replace the controller.	If the error cannot be resolved or is persistent, contact your installation engineer To replace the necessary parts, you must contact your installation engineer
F09 (lock out error) Water temperature protection.	Temperature at the top of the tank exceeds 93°C.	1. Check that the circulation pump (if present) is working 2. Check the position of temperature sensor T ₁ 3. Reset controller	If the error cannot be resolved or is persistent, contact your installation engineer
F11 (blocking error) Flame detection with closed gas control valve.	Defective gas control valves	See F07.	
F18 (blocking error) Communication error	No power supply at solar controller	1. Check that there is power to the solar heating system controller 2. The measured voltage must be 230 V _{AC} (-15%, +10%)	See the electrical diagram (17 "Appendices"). If the error persists, consult your installation engineer
	No cable or damaged cable	1. Check the wiring (communication cable) between the main controller and the solar heating system controller 2. If cable missing, connect the cable 3. If cable damaged, replace the cable	See the electrical diagram (17 "Appendices"). For replacement of the cable, contact your installation engineer

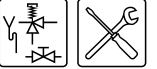

Code + description	Cause	Measure	Remark
F19 (blocking error) Power supply voltage is too low.	There is not enough supply voltage.	<ol style="list-style-type: none"> 1. Check that there is power to the controller 2. The measured voltage must be 230 V_{AC} (-15%, +10%) 	See the electrical diagram (17 "Appendices"). If the error persists, consult your installation engineer
C02 (lock out error) Error message from the controller.	Incorrect reference voltage from the AD converter.	<ol style="list-style-type: none"> 1. Reset controller. 2. Check that the frequency of the power supply is compliant (3.4.2 "General and electrical specifications"). If not, contact your installation engineer 3. If the frequency is correct but the error persists, replace the controller. 	To replace the necessary parts, you must contact your installation engineer
Internal error message from the controller.	<ul style="list-style-type: none"> • EEPROM read error • 50 Hz error • Internal communication error 		
Internal error message from the controller.	<ul style="list-style-type: none"> • Gas valve relay error • Safety relay error • Ignition relay error • RAM error • EEPROM error • EEPROM contents do not match the software version • Processor software error 		
C03 (blocking error) Reset error	Too many resets in too short a period	Wait for the error to disappear (maximum 1 hour). If the error does not disappear, replace the water heater controller.	To replace the necessary parts, you must contact your installation engineer

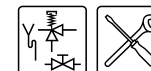

Code + description	Cause	Measure	Remark
C04 (blocking error) Appliance selection error	Incorrect water heater selection/Incorrect selection resistor	<ol style="list-style-type: none"> 1. Check whether the correct water heater is selected (3.4.2 "General and electrical specifications"). 2. If the correct water heater is selected, fit the correct selection resistor. 3. If incorrect water heater selected, select the correct one. 	<p>If the error cannot be resolved or is persistent, contact your installation engineer</p> <p>To replace the necessary parts, you must contact your installation engineer</p>
C05 (blocking error) Error message from the solar controller.	<ul style="list-style-type: none"> • Incorrect reference voltage from the AD converter. • EEPROM error 	<ol style="list-style-type: none"> 1. Reset controller. 2. Check that the frequency of the power supply is compliant (3.4.2 "General and electrical specifications"). If this is not the case, contact your installation engineer. 3. If the frequency is correct but the error persists, replace the solar controller. 	<p>If the error cannot be resolved or is persistent, contact your installation engineer</p> <p>To replace the necessary parts, you must contact your installation engineer</p>
E01 (blocking error) The temperature protection at the top of the tank has been activated.	The temperature of the water at the top of the tank is $>88^{\circ}\text{C}$.	None. This is a temporary message that may appear from time to time, but will disappear automatically.	
E03 (lock-out error) Error in temperature sensor T_1 at the top of the tank.	The two temperature sensors in the tank detect a difference of $> 10^{\circ}\text{C}$ over a period of at least 60 seconds.	<ol style="list-style-type: none"> 1. Check sensor position and wiring. 2. Reset the controller if necessary. Replace the sensor if the error persists. 	To replace the necessary parts, you must contact your installation engineer
E04 (lock-out error) Defect in the dummy sensor ⁽²⁾ .	The two temperature sensors detect a difference of $\geq 10^{\circ}\text{C}$ over a period of at least 60 seconds.	<ol style="list-style-type: none"> 1. Check the wiring of the dummy 1 and dummy 2. 2. Reset the controller if necessary. Replace the dummy sensor if the error persists. 	To replace the necessary parts, you must contact your installation engineer
<p>(1) Temperature sensor T_1 is a 2-in-1 sensor; T_1 contains 2 NTCs for maximum thermostat and safety thermostat protection.</p> <p>(2) The dummy flue gas sensor consists of dummy flue gas sensor 1 and dummy flue gas sensor 2.</p>			

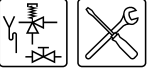

13.4 Warnings on the display

Warnings on the display

Situation	Cause	Measure	Note
Maximum burning hours: Servicing required.	The actual burning hours have exceeded the preset burning hours.	Appliance runs, but displays a warning	For maintenance to your appliance, please contact your installation engineer.

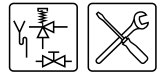

Situation	Cause	Measure	Note
The anode protection is not working.	<ul style="list-style-type: none"> The cables between the potentiostat and anodes are loose or have been connected incorrectly. The earth connection of the anodes is loose. The appliance is not filled with water. 	<p>Appliance runs, but displays a warning.</p> <hr/> <p>Note  The appliance is functioning, but there is no anode protection for the tank.</p> <hr/>	<ol style="list-style-type: none"> Connect the wiring up properly and the warning will disappear. If the wiring is correct but the warning remains, check that the earth connection is good and whether the tank is filled with water.
Solar heating system pump or Q/T sensor not correctly connected.	Lead(s) loosened or incorrectly connected	Appliance runs, but displays a warning	<ol style="list-style-type: none"> Connect the pump or Q/T sensor properly and the warning will disappear. If correctly wired but the warning remains, replace pump or sensor. <p>To replace the necessary parts, you must contact your installation engineer.</p>
Collector temperature too high.	Temperature S_1 is greater than $T_{\text{collector max}}$.	<p>Non-drainback systems:</p> <p>The solar systems pump runs at full power for 10 minutes, pumping the fluid in the solar system round. If $T_{\text{col}} > T_{\text{collector max}}$ after this has elapsed, the pump will stop running for 30 minutes. After 30 minutes, the pump will start running again and the controller of the solar heating system checks whether T_{col} is less than $T_{\text{collector max}}$.</p> <p>Drain-back systems:</p> <p>The solar system's pump stops running immediately (for 30 minutes). After 30 minutes, the pump will start running again and the controller of the solar heating system checks whether T_{col} is less than $T_{\text{collector max}}$.</p>	<ol style="list-style-type: none"> You can let the message disappear automatically by allowing the heating fluid to cool down. You can also manually eliminate the message by pressing the RESET and ENTER buttons simultaneously.

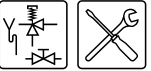

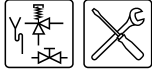

14 Service interval

14.1 Introduction

A service should be carried out at least once a year, both on the water side and on the gas side. Among other things, the service interval depends on the water quality, the average burning time per day and the set water temperature.

Note

 Regular maintenance extends the service life of the water heater.

To determine the correct service interval, it is recommended to arrange for the service and maintenance engineer to check the water heater on both the water and gas side three months after installation. Based on this check, the best service interval can be determined.

14.2 Determining service interval

The service interval is a feature of the controller to help the service and maintenance engineer set the maintenance frequency, based on the number of months that the appliance has been running.

The service interval can be set to: 6, 9 or 12 months. The default setting is 12 months.

Once the set number of months has elapsed, the message **SERVICE REQUIRED** will appear on the display. When this message appears, the service and maintenance engineer must be contacted.

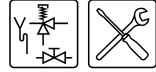



15 Performing maintenance

15.1 Introduction

Caution

Maintenance may only be carried out by an approved service and maintenance engineer.

At each service, the water heater undergoes maintenance on both the water side and the gas side. The maintenance must be carried out in the following order.



1. Preparation for maintenance
2. Water-side maintenance
3. Gas-side maintenance
4. Solar collector maintenance
5. Finalizing maintenance

Note

Before ordering spare parts, it is important to write down the installation type, water heater model, and the full serial number of the water heater. These details can be found on the rating plate. Only by ordering with this information can you be sure to receive the correct spare parts.

15.2 Preparation for maintenance

To test whether all components are still working properly, complete the following steps:

1. Activate the MENU with .
2. Use:  and  to place the cursor beside OFF.
3. Confirm OFF with ENTER.

```
MENU
→OFF
▲ ON
▼ WEEK PROGRAM
```

4. Wait until the fan has stopped. The  icon is then dimmed.

Caution

Failure to wait until the fan stops can cause damage to the water heater.

5. Switch the appliance **OFF (position 0)** using the ON/OFF switch on the control panel.



6. Switch the controller **ON** by setting the ON/OFF switch to **position I**.

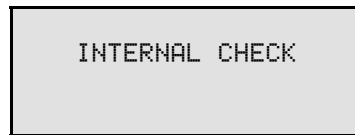

The display will now show `INTERNAL CHECK` for about 10 seconds, and will then go to the main menu.

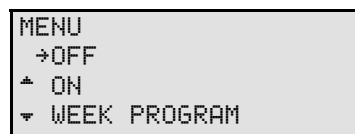

7. Activate "ON mode" by going through the following steps:
- Press once on the blue arrow (↓) to position the cursor beside `ON`, then press `ENTER`.
 - Confirm the selection `START OPERATION` with `ENTER`.
8. If there is no heat demand, then raise (11.4 "Setting the water temperature") T_{set} . Note the original setting. Draw some hot water off to create heat demand.
9. Check whether the heating cycle runs correctly (9.3 "The appliance's heating cycle").
10. If you have adjusted T_{set} , return it to the original value (11.4 "Setting the water temperature").
11. Remove the plastic cover on the top of the appliance.
12. Check the supply and burner pressures (3.13 "Check the supply pressure, gas control valve pressure, CO_2 value and switching pressure") and adjust them where necessary.
13. Check that all components of the chimney flue system are properly attached.
14. Check the pressure differential across the pressure switch (3.13.4 "Switching pressure measurement") and, if this is too low, the heat exchanger should be cleaned (15.4.3 "Clean heat exchanger").
15. Test the operation of the overflow valve of the protected cold supply setup. The water should spurt out.
16. Check the drainage pipes from the discharge points of all valves and remove any scale deposits that may be present.
17. Drain the water heater (see draining (6 "Draining")).

15.3 Water-side maintenance

15.3.1 Introduction

The following steps must be carried out on the water side:

1. Descaling and cleaning the tank.
2. Clean condensation water discharge.

15.3.2 Descaling and cleaning the tank

Scale and lime build-up prevent effective conduction of the heat to the water. Periodic cleaning and descaling prevents build-up of these deposits. This increases the service life of the water heater, and also improves the heating process.



Take the rate of scale formation into account when deciding on the service interval. Scale formation depends on the local water composition, the water consumption and the water temperature setting. A water temperature setting of maximum 60°C is recommended for the prevention of excessive scale build-up.

To guarantee a good, watertight seal around the cleaning opening, replace the gasket, washers, bolts and, if necessary, the lid with new parts before reassembly (see the figure). A special set is obtainable from the supplier/manufacturer.

To simplify descaling and cleaning of the tank, the water heater is equipped with two cleaning openings.

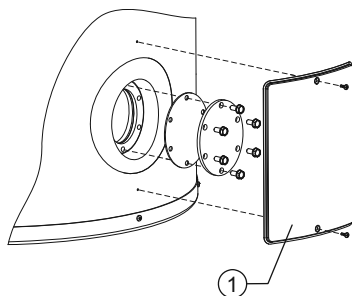

IMD-0080 R1

1. Remove the cover plate (1) on the outer jacket (see the figure).
2. Undo the bolts.
3. Remove the cover and the gasket.
4. Inspect the tank and remove the loose scale deposits and contamination.
5. If the scale cannot be removed by hand, descale the water heater with a descaling agent. Contact the supplier/manufacturer for advice on what descaling agent to use.
6. Close the cleaning opening. To avoid damage to the tank, tighten the bolts that fasten the lid with a torque no greater than 50 Nm. Use suitable tools for this.

15.3.3 Clean condensation water discharge

To prevent blockages, it is essential to clean the condensation water discharge and condensation trap regularly.

15.4 Gas-side maintenance

15.4.1 Introduction

The following steps must be carried out on the gas side:

1. Cleaning the burner.
2. Clean heat exchanger.
3. Finalizing maintenance.

15.4.2 Cleaning the burner

1. Detach the burner.
2. Remove all contamination present on the burner.
3. Fit the burner.



15.4.3 Clean heat exchanger

1. Detach the burner.
2. Clean the combustion chamber of the heat exchanger using a vacuum cleaner and a soft brush.
3. Detach the chimney flue.
4. Clean the end of the heat exchanger using tap water.
5. Fit the burner.
6. Fit the chimney flue.

Note

Check the pressure differential again after cleaning. If the pressure differential is too low following cleaning, please contact the supplier of the water heater.

15.5 Solar collector maintenance

See installation or users' manual for the solar collector. If this topic is not covered in the manual, then contact the supplier of the collectors.

15.6 Finalizing maintenance

See Errata.

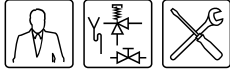

16 Warranty (certificate)

To register your warranty, you should complete and return the enclosed warranty card, after which a warranty certificate will be sent to you. This certificate gives the owner of an appliance supplied by A.O.Smith Water Products Company B.V. of Veldhoven, Netherlands (hereinafter "A.O.Smith") the right to the warranty set out below, defining the commitments of A.O.Smith to the owner.

16.1 General warranty

If, after verification and at the sole discretion of A.O.Smith, a component or part (with exclusion of the tank) of a water heater supplied by A.O.Smith proves within one year of the original installation date to be defective or fails to function correctly due to manufacturing and/or material defects, then A.O.Smith shall repair or replace this component or part.

16.2 Tank warranty

If, after inspection and at the sole discretion of A.O.Smith, the glass-lined steel tank of a water heater supplied by A.O.Smith proves within 3 years of the original installation date to be leaking due to rust or corrosion occurring on the water side, then A.O.Smith shall offer to replace the defective water heater with an entirely new water heater of equivalent size and quality. The warranty period given on the replacement water heater shall be equal to the remaining warranty period of the original water heater that was supplied. Notwithstanding that stated earlier in this article, in the event that unfiltered or softened water is used, or allowed to stand in the water heater, the warranty shall be reduced to one year from the original installation date.

16.3 Collector warranty

For warranty and installation and conditions of use, please see the manual included with the collectors.

16.4 Conditions for Installation and use

The warranty set out in articles 1 and 2 will apply solely under the following conditions:

- a. The water heater is installed under strict adherence to A.O.Smith installation instructions for the specific model, and the relevant government and local authority installation and building codes, rules and regulations in force at the time of installation.
- b. The water heater remains installed at the original site of installation.
- c. The water heater is used exclusively with drinking water, which at all times can freely circulate (a separately installed heat exchanger is mandatory for heating saline water or corrosive water).
- d. The tank is safeguarded against harmful scaling and lime build-up by means of periodic maintenance.
- e. The water temperatures in the heater do not exceed the maximum setting of the thermostats, which form a part of the water heater.
- f. The water pressure and/or heat load do not exceed the maximum values stated on the water heater rating plate.
- g. The water heater is installed in a non-corrosive atmosphere or environment.
- h. The water heater is connected to a protected cold supply arrangement, which is: approved by the relevant authority; with sufficient capacity for this purpose; supplying a pressure no greater than the working pressure stated on the water heater; and where applicable by a likewise approved temperature and pressure relief valve, fitted in accordance with installation instructions of A.O.Smith applying to the specific model of water heater, and further in compliance with the government and local authority installation and building codes, rules and regulations.

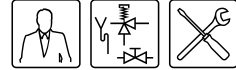

- i. The water heater is at all times fitted with cathodic protection. If sacrificial anodes are used for this, these must be replaced and renewed when, and as soon as, they are 60% or more consumed. When power anodes are used, it is important to ensure that they continue to work properly.

16.5 Exclusions

The warranty set out in articles 1 and 2 will not apply in the event of:

- a. damage to the water heater caused by an external factor;
- b. misuse, neglect (including frost damage), modification, incorrect and/or unauthorised use of the water heater and any attempt to repair leaks;
- c. contaminants or other substances having been allowed to enter the tank;
- d. the conductivity of the water being less than 125 $\mu\text{S}/\text{cm}$ and/or the hardness (alkaline earth ions) of the water being less than 1.00 mmol/litre (3.3.3 "Water composition");
- e. unfiltered, recirculated water flowing through or being stored in the water heater;
- f. any attempts at repair to a defective water heater other than by an approved service engineer.

16.6 Scope of the warranty

The obligations of A.O.Smith by virtue of the warranty provided do not extend beyond delivery free of charge from the warehouse of the parts or components or water heater to be replaced; transport, labour, installation and other costs associated with the replacement shall not be borne by A.O.Smith.

16.7 Claims

A claim on grounds of the specified warranty must be submitted to the dealer from whom the water heater was purchased, or to another authorised dealer for A.O.Smith Water Products Company products. Inspection of the water heater as referred to in articles 1 and 2 shall take place in one of the laboratories of A.O.Smith Water Products Company.

16.8 Obligations of A.O.Smith

A.O.Smith grants no other warranty or guarantee over its water heaters nor the (assemblies or parts of) water heaters supplied for replacement, other than the warranty expressly set out in this Certificate.

Under the terms of the supplied warranty, A.O.Smith is not liable for damage to persons or property caused by (assemblies or parts, or the glass-lined steel tank of) a (replacement) water heater that it has supplied.

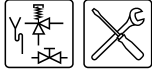

17 Appendices

17.1 Introduction

This appendix contains:

- Menu structure of the main menu ([17.2 "Menu structure"](#))
- Appliance electrical diagram ([17.3 "Electrical diagram for the appliance"](#))
- Electrical diagram, solar heating system ([17.4 "Electrical diagram, solar heating system"](#))
- Declaration of conformity ([17.5 "Declaration of conformity"](#))
- Week program card ([17.6 "Week program card"](#))

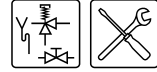

17.2 Menu structure

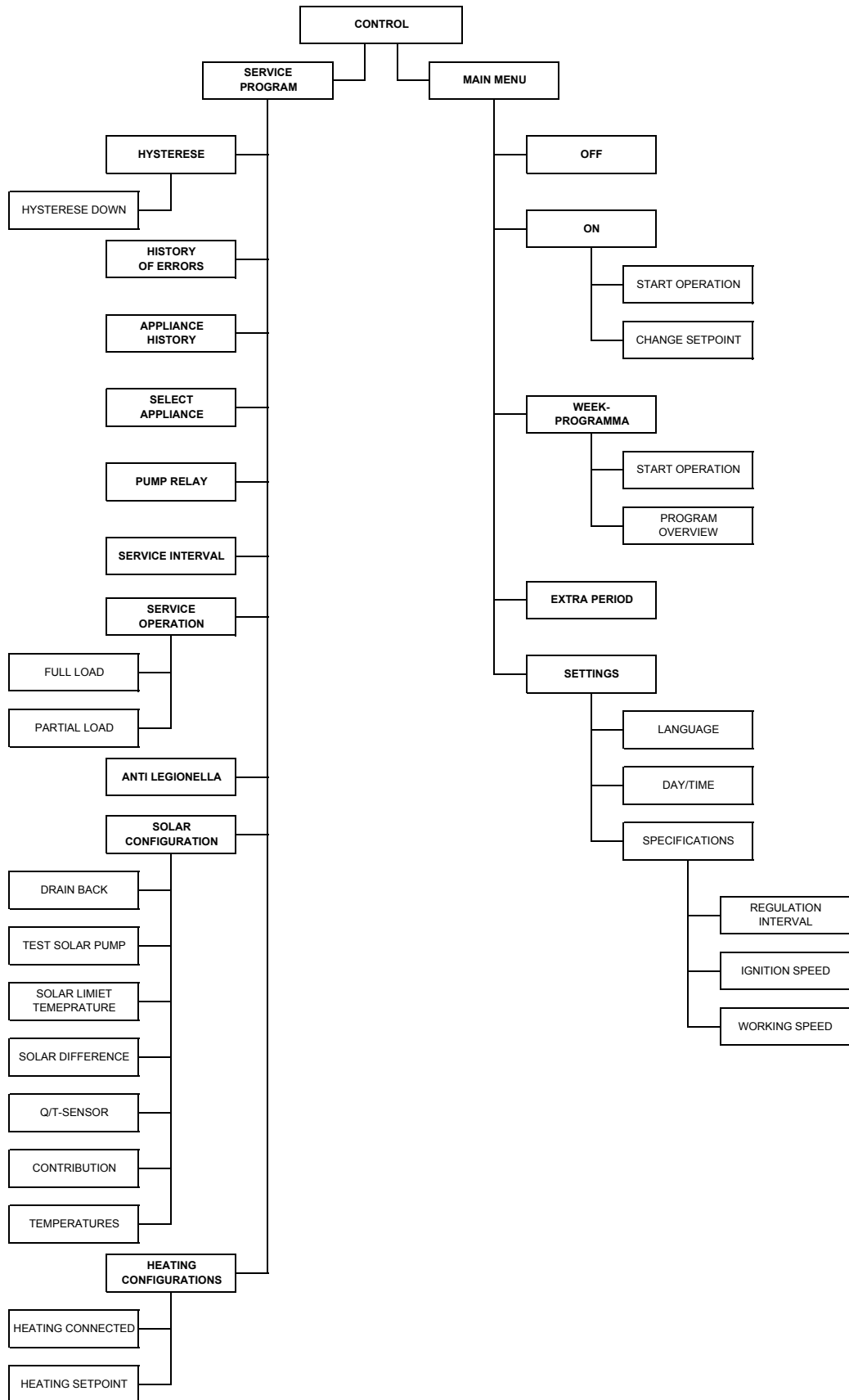



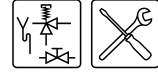

17.3 Electrical diagram for the appliance

Electrical diagram

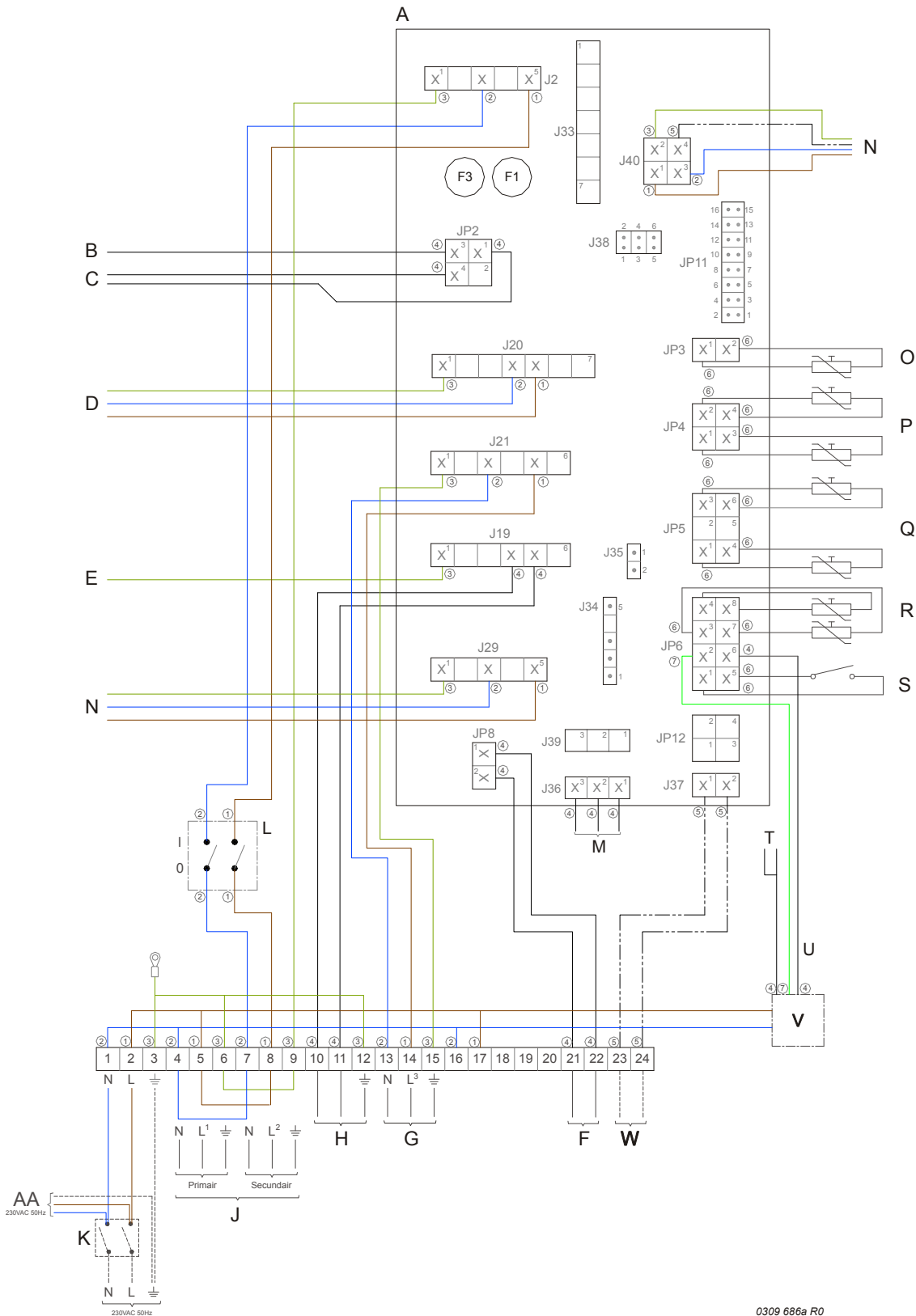

0309 686a R0

1 = brown, 2 = blue, 3 = yellow / green, 4 = black, 5 = white, 6 = grey / beige, 7 = green, 8 = yellow

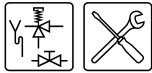

TERMINAL STRIP CONNECTIONS

⏚	Earth
N	Neutral
L	Live input of controller
L ¹	Live input of isolating transformer (primary side)
L ²	Live output of isolating transformer (secondary side)
L ³	Live input of program-controlled pump

COMPONENTS

A	Control
B	Flame probe
C	Hot surface igniter
D	Gas control valve
E	Burner earth connection
F	Extra ON mode switch
G	Program-controlled pump (max. 100W)
H	Extra error signal connection
J	Isolating transformer
K	Double-pole isolator
L	Controller O/I switch
M	Display
N	Fan
O	Temperature sensor (T ₂ - bottom of tank)
P	Dummy
Q	Temperature sensor (T ₁ - top of tank)
R	Selection resistor
S	Push button
T	Electrical anodes
U	Signalling for electrical anodes
V	Potentiostat
W	Communication between the appliance controller and the solar system (BUS connection)
AA	Solar system controller

CONTROLLER CONNECTIONS

J2	Power connection for controller
J19	Extra error signal connection
J20	Gas control valve connection
J21	Program-controlled pump connection
J29	Power connection for the fan
J36	Controller display connection
J40	Regulator connection for the fan
JP2	Flame probe and hot surface igniter connection
JP3	Temperature sensor T ₂ connection
JP4	Dummy connection
JP5	Temperature sensor T ₁ connection
JP6	Selection resistor and pressure switch connection
JP8	Extra ON mode switch connection
F1	Fuse (T 3.15A - 250 V)
F3	Fuse (T 3.15A - 250 V)

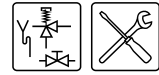

17.4 Electrical diagram, solar heating system

Electrical diagram, see Errata.



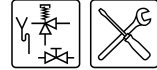

17.5 Declaration of conformity

Declaration of conformity



EEC - Declaration of Conformity

Supplier: A.O. Smith Water Products Company b.v.
De Run 5305
5503 LW Veldhoven
The Netherlands

hereby declares that the following products:

Product description: Commercial Gas fired Storage Water Heater

Product models: SGE 40, SGE 60

on the assumption that the installation instructions have been followed are compliant to:

Gas Appliance Directive (GAD) - 90/396/EEC

Standards used:

- EN 89: 1999

Low Voltage Directive (LVD) - 2006/95/EC

Standards used:

- EN 60335-1: 2002
- EN 60335-2-102: 2006

EMC Directive (EMC) - 2004/108/EC

Standards used:

- EN 55014-1: 2000
- EN 55014-2: 1997
- EN 61000-3-2: 2006
- EN 61000-3-3: 1995

as stated in the EC type-examination report by KIWA-Gastec Certification BV, The Netherlands:

Report Number: 178889

Company:
A.O. Smith Water Products Company b.v.

Date:
November 1, 2009

Signature:

T. van der Hamsvoort
Managing Director

17.6 Week program card

You can cut the week program card out and keep it near the water heater.

Period		DAY	TIME	Tset	Pump
1.	ON		°C	ON / OFF
	OFF				
2.	ON		°C	ON / OFF
	OFF				
3.	ON		°C	ON / OFF
	OFF				
4.	ON		°C	ON / OFF
	OFF				
5.	ON		°C	ON / OFF
	OFF				
6.	ON		°C	ON / OFF
	OFF				
7.	ON		°C	ON / OFF
	OFF				
8.	ON		°C	ON / OFF
	OFF				
9.	ON		°C	ON / OFF
	OFF				
10.	ON		°C	ON / OFF
	OFF				
11.	ON		°C	ON / OFF
	OFF				

Example

Period		DAY	TIME	Tset	Pump
1.	ON	MO	14:30	70 °C	ON / OFF
	OFF	MO	16:15		

Period		DAY	TIME	Tset	Pump
12.	ON		°C	ON / OFF
	OFF				
13.	ON		°C	ON / OFF
	OFF				
14.	ON		°C	ON / OFF
	OFF				
15.	ON		°C	ON / OFF
	OFF				
16.	ON		°C	ON / OFF
	OFF				
17.	ON		°C	ON / OFF
	OFF				
18.	ON		°C	ON / OFF
	OFF				
19.	ON		°C	ON / OFF
	OFF				
20.	ON		°C	ON / OFF
	OFF				
21.	ON		°C	ON / OFF
	OFF				





Index

A

- actuation 67
- ambient conditions 19
- ambient temperature 20

C

- claims 104
- connecting the air supply 29
- connecting the chimney flue 29
- connecting the circulation pipe 26, 27
- connecting the cold water side 26, 27
- connecting the hot water side 26
- conversion to a different gas category 47

D

- descaling 100
- displaying error history 75
- draining 53
- draining the solar heating system 55

E

- electrical connection 34
- error 60
- extra period
 - setting 72

F

- fan 16
- filling 49
- filling the solar heating system 51
- flame probe 16

G

- gas category, conversion to different 47
- gas connection 28
- general specifications 3

H

- humidity 20

I

- installation diagram 25
- installation engineer 10

J

- join
 - air supply 29
 - circulation pipe 26, 27
 - cold water side 26, 27
 - electrical 34
 - flue gas discharge 29
 - gas 28
 - hot water side 26

L

- language setting 73
- liability 3

M

- maintenance
 - condensation water discharge 101
 - descaling 100
 - gas-side 101
 - heat exchanger 102
 - preparation 99
 - scale 100
- mode
 - ERROR 60
 - SERVICE REQUIRED 60

N

- navigation buttons 58
- notation conventions 11

O

- ON mode 67
- ON/OFF switch 57
- operating cycle 14

P

- packaging 19
- PC connection 58
- protection 15
 - protection for the solar heating system 17
- pump 76

S

- safety
 - collector temperature warning 61
 - Q/T Sensor warning 61
 - solar heating system 18
- scale 100
- scrolling 58
- service 11, 97
- service engineer 10
- service required 60
- setting date 74
- setting the service interval 76
- shutting down
 - electrically isolating 65
 - long period 65
 - short period 65
- solar heating system
 - collector temperature 61
 - collector temperature warning 61
 - draining 55
 - filling 51
 - fluid temperature safety device 17
 - join
 - communication cable 39
 - connecting the solar collector 39
 - Extra head pump 40
 - pump station 38
 - Q/T sensor 40
 - tank sensor 39
 - Q/T Sensor warning 61
 - solar heating system 17
- specifications 21

symbol

- installation engineer 10
- service engineer 10
- user 10

T

- target groups 10
- terminal block 35
- ThermoControl
 - ON/OFF switch 57
- trademarks 3

U

- user 10

W

- warranty 103
 - exclusions 104
 - General information 103
 - installation and conditions of use 103
 - scope 104
- water
 - composition 20
- water heater
 - displaying history 76
 - displaying the selection 76
 - types 9, 19